

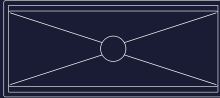









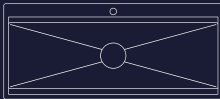
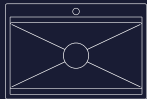

ARTINOX

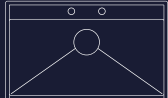
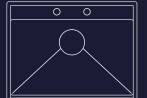
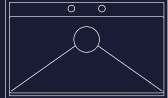
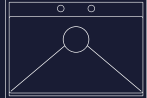
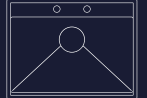

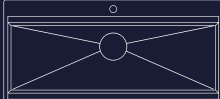
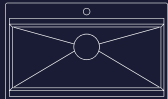
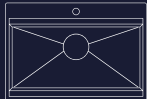
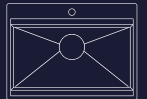

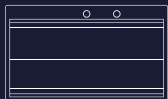
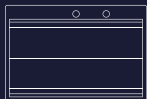
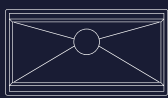
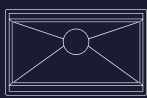
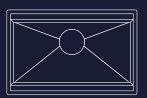

























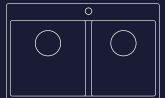
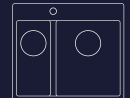

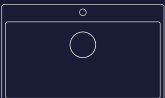
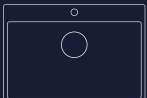

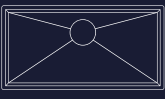
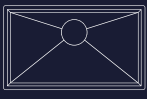
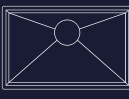

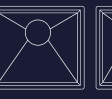



WORKSTATION SINKS

VISUAL INDEX

WORKSTATIONS

	120	90	80	75	60
PLANUM	 Pg. 21	 22	 23		
	 Pg. 27	 28	 29		
	 Pg. 31	 32	 33		
NEWGO		 39	 40	 41	
		 45	 46	 47	
LAYER	 Pg. 54	 55			
	 Pg. 59	 60	 61	 62	 63
		 66	 67		
	 70	 71	 72	 73	

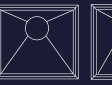
SINKS

	90	80	75	60	45
TITANIUM		 79		 80	 81
		 83		 84	 85
		 87		 88	 89
RADIUS		 95		 96	 97
	 Pg. 101	 102	 103	 104	 105
				 106	 107
GHOST				 111	
MOSE	 Pg. 116	 117			
	 Pg. 118	 119			
AQUA	 Pg. 124	 125	 126	 127	
PRISMA	 Pg. 133	 134	 135	 136	 137
				 138	 139
LINEA		 144	 145	 146	 147
				 148	 149
SHORE		 154	 155	 156	 157
				 158	 159

WORKSTATION SINKS

STORIA E PASSIONE

Artinox è stata fondata nel 1985 da Mario Zanardo a Conegliano, in una fra le più importanti aree industriali italiane specializzate nella lavorazione dell'acciaio. Tutte le nostre collezioni, dedicate al mercato delle cucine di alta gamma, sono disegnate e prodotte con passione all'interno del nostro stabilimento per essere distribuite in tutto il mondo.



QUALITÀ E SOSTENIBILITÀ

Oltre alle qualità intrinseche della materia prima, siamo impegnati nell'implementazione del nostro sistema di gestione ambientale: in Artinox utilizziamo da sempre il controllo di tutti i processi per garantire il massimo risultato delle prestazioni offerte – certificazione ISO 9001 –, prendendoci cura dei fattori che interagiscono con l'ambiente – ISO 14001 –.



WORKSTATION, DESIGN INNOVATIVO

In Artinox rivoluzioniamo il tempo passato in cucina. Tutte le workstation si integrano al piano di lavoro diventando un tutt'uno: il sistema sliding permette il posizionamento e lo scorrimento di infiniti accessori dedicati a molteplici funzionalità, dalle griglie ai supporti, dai taglieri ai contenitori fatti per durare e per servire con un semplice gesto.



IL NOSTRO ACCIAIO INOX

Il nostro acciaio è inossidabile ed è utilizzato in ambienti sia domestici che professionali, conforme a tutti gli standard di settore. È estremamente facile da pulire grazie alla superficie priva di pori, che comporta un'alta proprietà antibatterica. Il nostro acciaio è inalterabile nel tempo, è composto per oltre il 70% da materiali riciclati ed è riciclabile al 100%.





DETTAGLI CHE FANNO LA DIFFERENZA

Accessori dedicati

Gli accessori in acciaio inox, sempre prodotti in alto spessore nei nostri stabilimenti, sono lavabili in lavastoviglie. I taglieri sono in legno o in polietilene atossico.

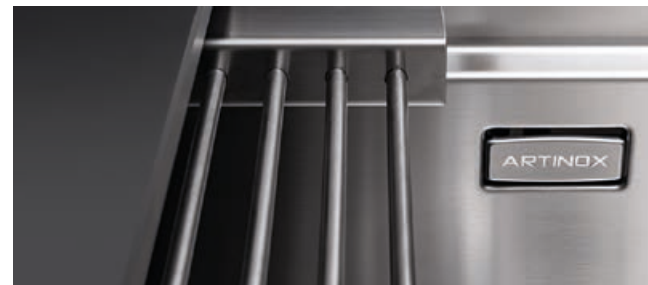

Acciaio di alto spessore

Utilizziamo acciaio inossidabile AISI 304 di spessore maggiorato rispetto ai normali standard di mercato, garantendo prodotti robusti dal design unico.



Prodotti saldati

In Artinox produciamo sistemi di lavaggio con angoli interni saldati a raggio 10 mm o zero/45. Design unico e contemporaneo.

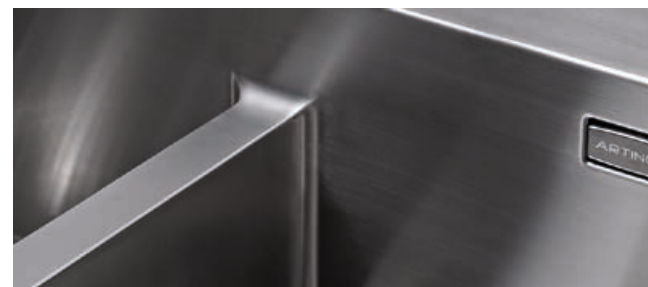

Dimensioni capienti

Le collezioni sono disponibili in molteplici dimensioni e con profondità da 170 a 250 mm. Garanzia, grande capienza e praticità operativa.



Fori miscelatori

Tutti i modelli delle nostre collezioni sono predisposti con uno o due fori diametro 35 mm per l'alloggio del miscelatore. È possibile richiedere fori aggiuntivi.



Kit saltarello

I pratici kit saltarello push evitano di bagnarsi le mani e sono in abbinamento alle finiture Artinox. Prodotti da selezionati partner italiani.



Trooppieno

Il trooppieno è integrato sulla parete posteriore, senza giunture per garantire la massima igiene.



Fondi inclinati

Il deflusso dell'acqua è sempre garantito da un invito in prossimità della piletta.

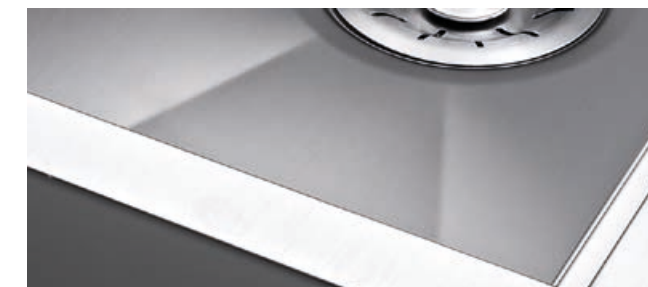

Pilette 3 1/2"

Le esclusive pilette dei nostri modelli sono prodotti da selezionati partner italiani. Tutti i modelli, le varianti e le colorazioni sono sempre in acciaio inox.



Sifoni salvaspazio

Il sifone salvaspazio è un accessorio disponibile per tutte le nostre collezioni. Le dimensioni contenute e la facile orientabilità aumentano lo spazio sotto il lavello.

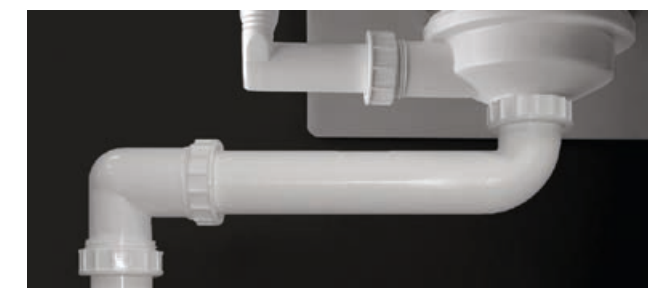

UN ALLESTIMENTO PER OGNI STILE

Sopratop

Il sopratop permette sempre la facile installazione su piani di qualsiasi materiale.

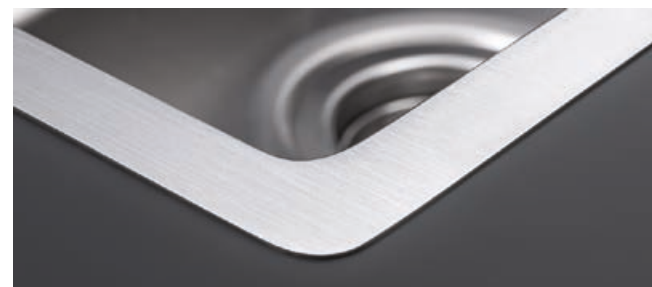

Filotop

L'elegante perimetro a vista filotop ha il bordo rettificato con una tolleranza di due decimi.



Sottotop

La soluzione sottotop permette di sfruttare al massimo la superficie del piano di lavoro.



Edgeless

Con Edgeless le giunzioni con il piano di lavoro spariscono. Massima igiene ed estetica.

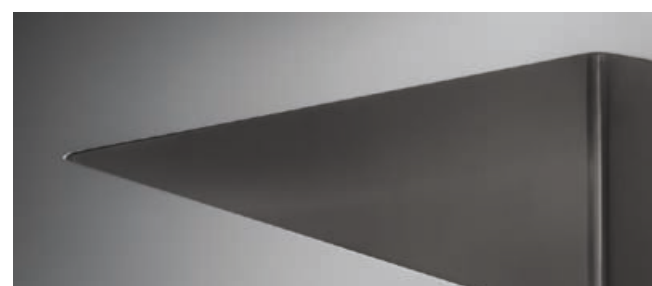

Fondo Integrato

L'innovativa installazione con fondo in inox e pareti in continuità con il piano di lavoro.



INDICE

WORKSTATIONS

PLANUM	18
NEWGO	36
LAYER	50

SINKS

TITANIUM	76
RADIUS	92
GHOST	110
MOSE	114
AQUA	122
PRISMA	130
LINEA	142
SHORE	152

MISCELATORI	162
-------------	-----

COMPLEMENTI	170
-------------	-----

PRODOTTI PER LA PULIZIA	172
-------------------------	-----

CONDIZIONI DI VENDITA	174
-----------------------	-----

PLANUM



PLANUM XL

La workstation in acciaio inox dalle grandi dimensioni, per goderti al meglio il tempo in cucina. Il sistema sliding permette il posizionamento e lo scorrimento di infiniti accessori dedicati a molteplici funzionalità: dalle griglie ai supporti, dai taglieri ai contenitori. Per durare e per servire con un semplice gesto.



PLANUM XL 111

READY

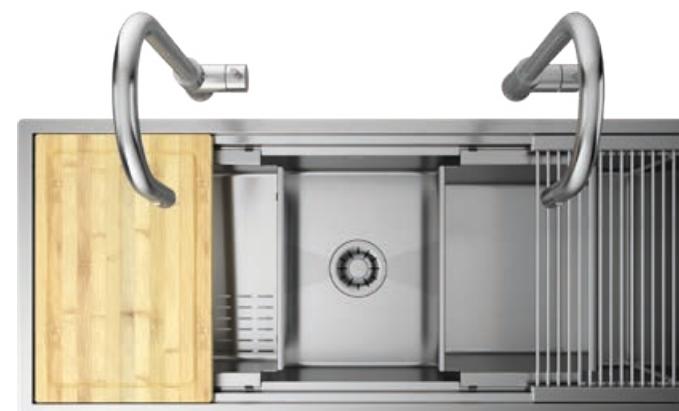

- Tagliere in legno **1**
- Vaschetta inclinata forata **23**
- Vaschetta **26**
- Griglia **10**
- Miscelatore Loft **38**
- Miscelatore Loft **38**

 Sopratop

Cod. **SAP I 11**

PLANUM XL 111

PRO



- Tagliere in legno **1**
- Vaschetta inclinata forata **23**

 Sopratop

Cod. **SBP I 11**

PLANUM XL 111

SOLO



- | | |
|------------------|---------------|
| Materiale | AISI 304 |
| Finitura | Spazzolato |
| Raggio interno | Saldato 10 mm |
| Misure esterne | 1160 × 510 mm |
| Misure vasca | 1110 × 400 mm |
| Profondità vasca | 254 mm |
| Piletta Plus | 3 1/2" |
| Base | 1200 mm |

 Sopratop

Cod. **PI 11 4025**

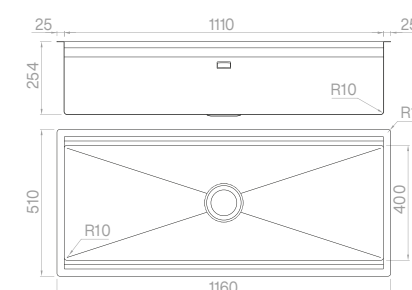

Accessori



Vedi pag. 25 per tutti gli accessori dedicati.

PLANUM XL 81 **READY**

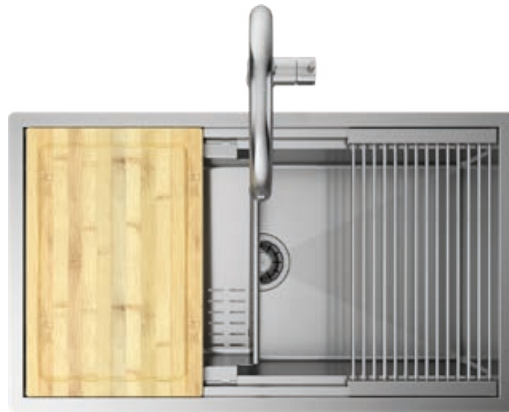

- Tagliere in legno **1**
- Vaschetta inclinata forata **23**
- Griglia **10**
- Miscelatore Loft **38**

 Sopratop Cod. **SAP I 81**

PLANUM XL 70 **READY**

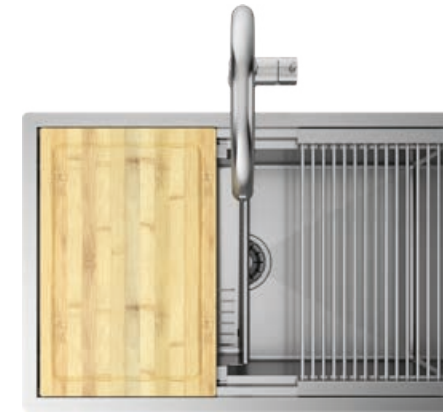

- Tagliere in legno **1**
- Vaschetta inclinata forata **23**
- Griglia **10**
- Miscelatore Loft **38**

 Sopratop Cod. **SAP I 70**

PLANUM XL 81 **PRO**



- Tagliere in legno **1**
- Vaschetta inclinata forata **23**

 Sopratop Cod. **SBP I 81**

PLANUM XL 70 **PRO**



- Tagliere in legno **1**
- Vaschetta inclinata forata **23**

 Sopratop Cod. **SBP I 70**

PLANUM XL 81 **SOLO**



Materiale	AISI 304
Finitura	Spazzolato
Raggio interno	Saldato 10 mm
Misure esterne	860 × 510 mm
Misure vasca	810 × 400 mm
Profondità vasca	254 mm
Piletta Plus	3 ½"
Base	900 mm

 Sopratop Cod. **PI 81 4025**

PLANUM XL 70 **SOLO**



Materiale	AISI 304
Finitura	Spazzolato
Raggio interno	Saldato 10 mm
Misure esterne	750 × 510 mm
Misure vasca	700 × 400 mm
Profondità vasca	254 mm
Piletta Plus	3 ½"
Base	800 mm

 Sopratop Cod. **PI 70 4025**

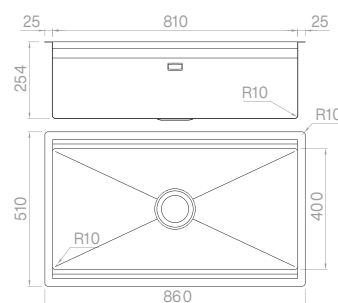

Accessori



Vedi pag. 25 per tutti gli accessori dedicati.

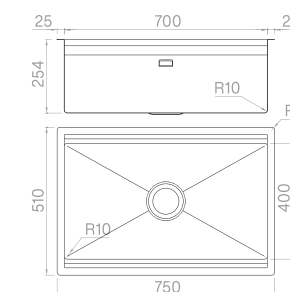

Accessori



Vedi pag. 25 per tutti gli accessori dedicati.

Tagliere in legno

1

300×457×20 mm
Cod. **TRIB 3045****Tagliere in HDPE**

6

240×420×20 mm
Cod. **TRP 2442****Set porta bottiglie**

7

130×457×170 mm
Cod. **VPB 3C****Gocciolatoio**

8

250×457×15 mm
Cod. **VPB 2545****Griglia**

10

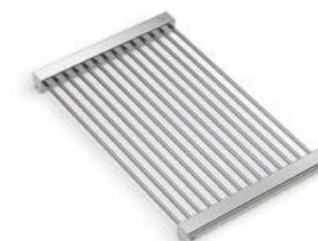
300×457×25 mm
Cod. **GRS 3045****Vaschetta forata**

16

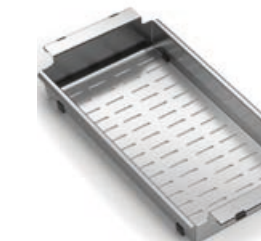
210×420×60 mm
Cod. **VQSF 2142****Vaschetta inclinata forata**

23

280×420×110/60 mm
Cod. **VQSI 2842****Vaschetta**

26

280×420×160 mm
Cod. **VQSP 2842****Set gastronorm**

30

240×420×100 mm
Cod. **TI 2442 V****Set scolapasta**

32

240×420×100 mm
Cod. **TI 2442 1S****Set grattugie**

34

200×420×20 mm
Cod. **TI 2442 PG****Porta piatti**

36

250×420×55 mm
Cod. **PPPB V400**

PLANUM BR

Tutte le workstation Planum si caratterizzano per il doppio livello di scorrimento. Molteplici combinazioni fra accessori garantiscono la massima personalizzazione dell'area operativa.



PLANUM BR 111

READY



- Tagliere in legno 2
- Vaschetta inclinata forata 25
- Vaschetta 27
- Griglia 11
- Miscelatore Loft 38

Sopratop

Cod. **SAP BRI 11**

PLANUM BR 111

PRO



- Tagliere in legno 2
- Vaschetta inclinata forata 25

Sopratop

Cod. **SBP BRI 11**

PLANUM BR 111

SOLO



- | | |
|------------------|---------------|
| Materiale | AISI 304 |
| Finitura | Spazzolato |
| Raggio interno | Saldato 10 mm |
| Misure esterne | 1160 × 505 mm |
| Misure vasca | 1110 × 350 mm |
| Profondità vasca | 224 mm |
| Piletta Plus | 3 1/2" |
| Base | 1200 mm |

Sopratop

Cod. **ALP BRI 11**

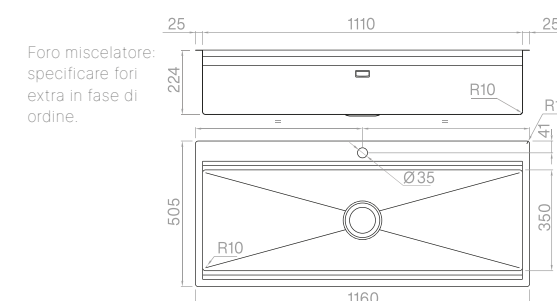

Accessori



Vedi pag. 35 per tutti gli accessori dedicati.

PLANUM BR 81 **READY**

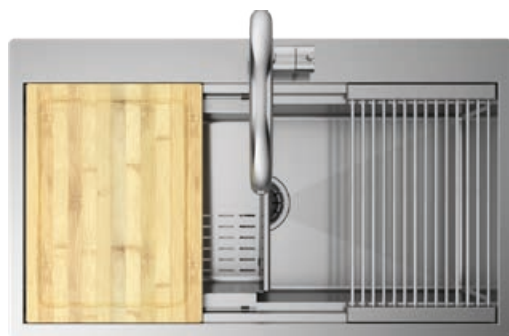

- Tagliere in legno **2**
- Vaschetta inclinata forata **25**
- Griglia **11**
- Miscelatore Loft **38**



Cod. **SAP BRI 81**

PLANUM BR 70 **READY**

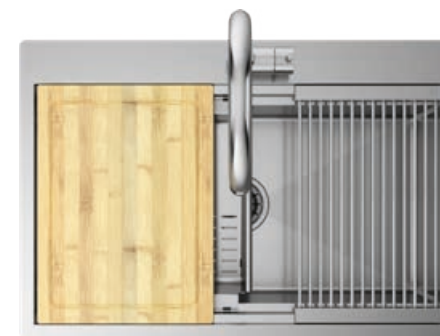

- Tagliere in legno **2**
- Vaschetta inclinata forata **25**
- Griglia **11**
- Miscelatore Loft **38**



Cod. **SAP BRI 70**

PLANUM BR 81 **PRO**



- Tagliere in legno **2**
- Vaschetta inclinata forata **25**



Cod. **SBP BRI 81**

PLANUM BR 70 **PRO**



- Tagliere in legno **2**
- Vaschetta inclinata forata **25**



Cod. **SBP BRI 70**

PLANUM BR 81 **SOLO**



Materiale	AISI 304
Finitura	Spazzolato
Raggio interno	Saldato 10 mm
Misure esterne	860 × 505 mm
Misure vasca	810 × 350 mm
Profondità vasca	224 mm
Piletta Plus	3 ½"
Base	900 mm



Cod. **ALP BRI 81**

PLANUM BR 70 **SOLO**



Materiale	AISI 304
Finitura	Spazzolato
Raggio interno	Saldato 10 mm
Misure esterne	750 × 505 mm
Misure vasca	700 × 350 mm
Profondità vasca	224 mm
Piletta Plus	3 ½"
Base	800 mm



Cod. **ALP BRI 70**

Foro miscelatore:
specificare fori extra
in fase di ordine.

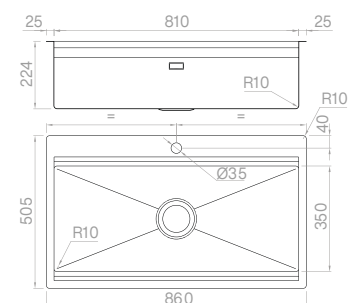

Accessori



Vedi pag. 35 per tutti gli accessori dedicati.

Foro miscelatore:
specificare fori extra
in fase di ordine.

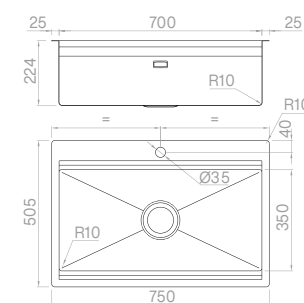

Accessori



Vedi pag. 35 per tutti gli accessori dedicati.

PLANUM ST

La funzionalità della collezione Planum in uno spazio più contenuto. L'installazione sottotop permette di sfruttare al massimo la superficie del piano di lavoro.



PLANUM ST 111

READY



- Tagliere in legno 2
- Vaschetta inclinata forata 25
- Vaschetta 27
- Griglia 11
- Miscelatore Loft 38

Sottotop

Cod. **SAPO 11 L1**

PLANUM ST 111

PRO



- Tagliere in legno 2
- Vaschetta inclinata forata 25

Sottotop

Cod. **SBPO 11 L1**

PLANUM ST 111

SOLO



- | | |
|------------------|---------------|
| Materiale | AISI 304 |
| Finitura | Spazzolato |
| Raggio interno | Saldato 10 mm |
| Misure esterne | 1150 × 440 mm |
| Misure vasca | 1110 × 350 mm |
| Profondità vasca | 204 mm |
| Piletta Plus | 3 ½" |
| Base | 1200 mm |

Sottotop

Cod. **PO 11 L1**

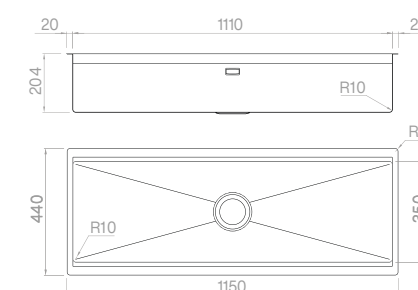

Accessori



Vedi pag. 35 per tutti gli accessori dedicati.

PLANUM ST 81 **READY**

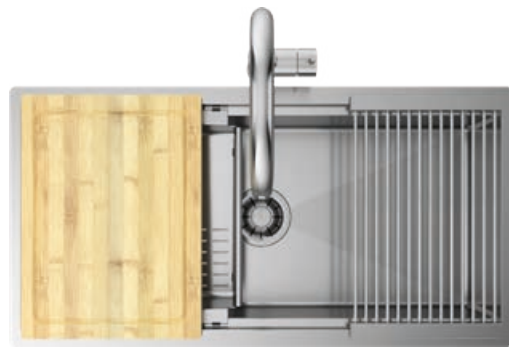

- Tagliere in legno **2**
- Vaschetta inclinata forata **25**
- Griglia **11**
- Miscelatore Loft **38**

Sottotop Cod. **SAPO 81 L1**

PLANUM ST 70 **READY**

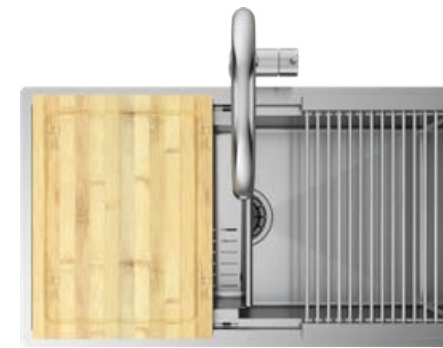

- Tagliere in legno **2**
- Vaschetta inclinata forata **25**
- Griglia **11**
- Miscelatore Loft **38**

Sottotop Cod. **SAPO 70 L1**

PLANUM ST 81 **PRO**

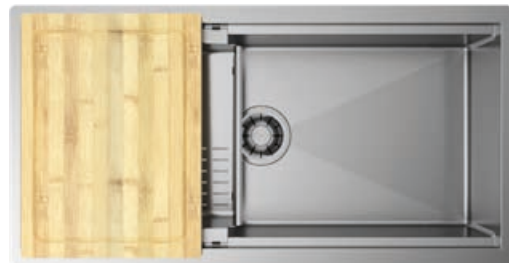

- Tagliere in legno **2**
- Vaschetta inclinata forata **25**

Sottotop Cod. **SBPO 81 L1**

PLANUM ST 70 **PRO**



- Tagliere in legno **2**
- Vaschetta inclinata forata **25**

Sottotop Cod. **SBPO 70 L1**

PLANUM ST 81 **SOLO**



Materiale	AISI 304
Finitura	Spazzolato
Raggio interno	Saldato 10 mm
Misure esterne	850 × 440 mm
Misure vasca	810 × 350 mm
Profondità vasca	204 mm
Piletta Plus	3 ½"
Base	900 mm

Sottotop Cod. **PO 81 L1**

PLANUM ST 70 **SOLO**



Materiale	AISI 304
Finitura	Spazzolato
Raggio interno	Saldato 10 mm
Misure esterne	740 × 440 mm
Misure vasca	700 × 350 mm
Profondità vasca	204 mm
Piletta Plus	3 ½"
Base	800 mm

Sottotop Cod. **PO 70 L1**

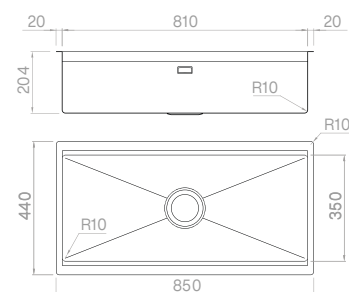

Accessori



Vedi pag. 35 per tutti gli accessori dedicati.

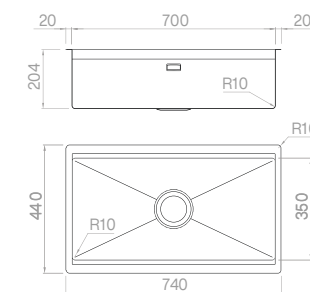

Accessori



Vedi pag. 35 per tutti gli accessori dedicati.

**Tagliere in legno**

2

300×407×20 mm
Cod. **TRIB 3041**

**Gocciolatoio**

9

250×407×15 mm
Cod. **VPB 2541**

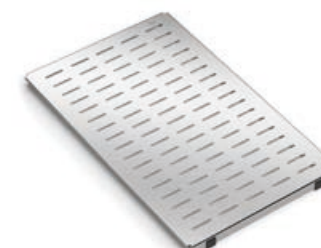
**Griglia**

11

300×407×25 mm
Cod. **GRS 3041**

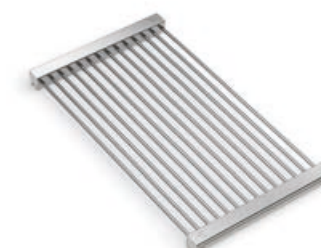
**Vaschetta forata**

20

210×375×60 mm
Cod. **VQSF 2137**

**Vaschetta inclinata forata**

25

280×370×110/60 mm
Cod. **VQSI 2837**

**Vaschetta**

27

280×370×140 mm
Cod. **VQSP 2837**

**Set tagliere + gastronorm**

31

300×405×100 mm
Cod. **TPLB 3V**

**Set tagliere + colapasta**

33

300×405×100 mm
Cod. **TPLB 1S**

**Set tagliere + telaio porta coltelli**

35

300×405×20 mm
Cod. **TPLB 4030**





NEWGO MATTE VINTAGE

Una workstation elegante e sofisticata grazie all'abbinamento fra l'acciaio Matte Vintage e la finitura nera dei miscelatori e degli accessori.



NEWGO 81 MATTE VINTAGE

READY



- Griglia matte vintage **13**
- Vaschetta inclinata forata matte vintage **24**
- Miscelatore Ergo **41**

- Sopratop
- Filotop

Cod. **SAG I 81H**
Cod. **SAGG 81H**

NEWGO 81 MATTE VINTAGE

PRO



- Griglia matte vintage **13**

- Sopratop
- Filotop

Cod. **SBG I 81H**
Cod. **SBGG 81H**

NEWGO 81 MATTE VINTAGE

SOLO



- Materiale AISI 304
- Finitura Spazzolato opaco
- Raggio interno Saldato 10 mm
- Misure esterne 850 × 530 mm
- Misure vasca 810 × 400 mm
- Profondità vasca 220 mm
- Piletta automatica nera 3 1/2"
- Base 900 mm

- Sopratop
- Filotop

Cod. **ALG I 81H**
Cod. **ALGG 81H**

Foro miscelatore:
specificare fori extra
in fase di ordine.

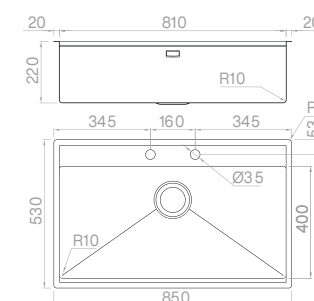

Accessori



Vedi pag. 43 per tutti gli accessori dedicati.

NEWGO 70 MATTE VINTAGE

READY



- Griglia matte vintage **13**
- Vaschetta inclinata forata matte vintage **24**
- Miscelatore Ergo **41**



Cod. **SAG I 70H**
Cod. **SAGG 70H**

NEWGO 70 MATTE VINTAGE

PRO

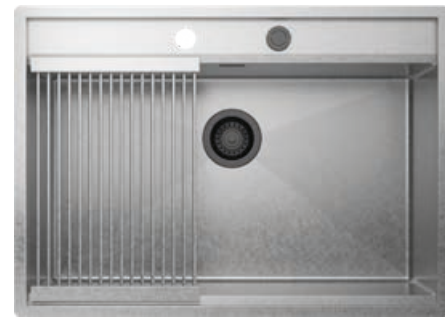

- Griglia matte vintage **13**



Cod. **SBG I 70H**
Cod. **SBGG 70H**

NEWGO 70 MATTE VINTAGE

SOLO



- Materiale AISI 304
- Finitura Spazzolato opaco
- Raggio interno Saldato 10 mm
- Misure esterne 740 × 530 mm
- Misure vasca 700 × 400 mm
- Profondità vasca 220 mm
- Piletta automatica nera 3 ½"
- Base 800 mm



Cod. **ALG I 70H**
Cod. **ALGG 70H**

Foro miscelatore:
specificare fori extra
in fase di ordine.

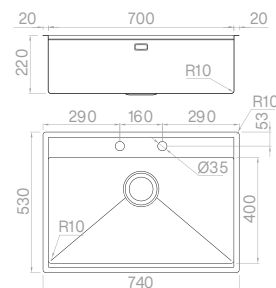

Accessori



Vedi pag. 43 per tutti gli accessori dedicati.

NEWGO 65 MATTE VINTAGE

READY

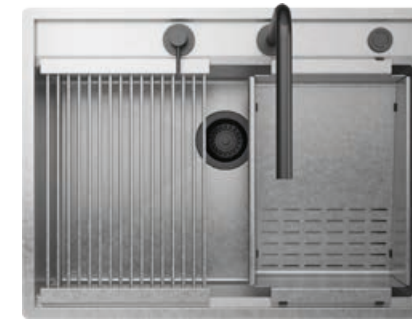

- Griglia matte vintage **13**
- Vaschetta inclinata forata matte vintage **24**
- Miscelatore Ergo **41**



Cod. **SAG I 65H**
Cod. **SAGG 65H**

NEWGO 65 MATTE VINTAGE

PRO

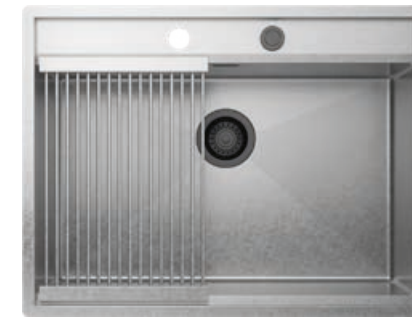

- Griglia matte vintage **13**



Cod. **SBG I 65H**
Cod. **SBGG 65H**

NEWGO 65 MATTE VINTAGE

SOLO



- Materiale AISI 304
- Finitura Spazzolato opaco
- Raggio interno Saldato 10 mm
- Misure esterne 690 × 530 mm
- Misure vasca 650 × 400 mm
- Profondità vasca 220 mm
- Piletta automatica nera 3 ½"
- Base 750 mm



Cod. **ALG I 65H**
Cod. **ALGG 65H**

Foro miscelatore:
specificare fori extra
in fase di ordine.

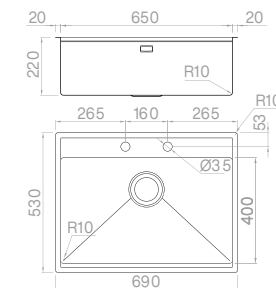

Accessori



Vedi pag. 43 per tutti gli accessori dedicati.

Tagliere in legno

300×420×20 mm
Cod. **TRIB 3042**

**3****Tagliere in HDPE**

240×420×20 mm
Cod. **TRP 2442**

**6****Griglia matte vintage**

250×420×25 mm
Cod. **GRH 2542**

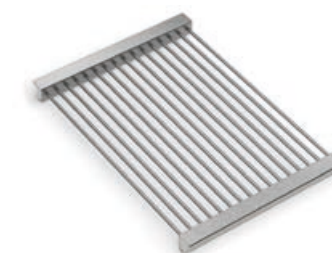
**13****Vaschetta inclinata forata matte vintage**

280×420×110/60 mm
Cod. **VQHI 2842**

**24****Set gastronorm**

240×420×100 mm
Cod. **TI 2442 V**

**30****Set colapasta**

240×420×100 mm
Cod. **TI 2442 1S**

**32****Set grattugie**

200×420×20 mm
Cod. **TI 2442 PG**

**34****Porta piatti**

250×420×55 mm
Cod. **PPPB V400**

**36**

NEWGO

La profondità maggiorata e il ribassamento perimetrale consentono l'alloggiamento del miscelatore all'interno dell'area operativa.



NEWGO 81

READY

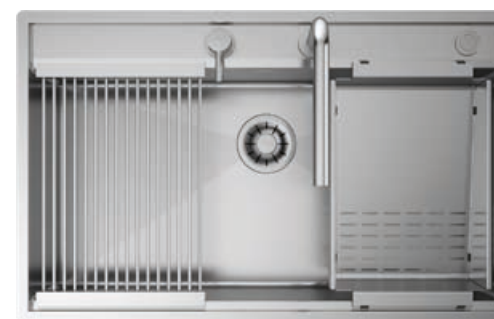

- Griglia 12
- Vaschetta inclinata forata 23
- Miscelatore Circle 45



Cod. **SAG I 81**
Cod. **SAGG 81**

NEWGO 81

PRO



- Griglia 12



Cod. **SBG I 81**
Cod. **SBGG 81**

NEWGO 81

SOLO



- Materiale AISI 304
- Finitura Spazzolato
- Raggio interno Saldato 10 mm
- Misure esterne 850 × 530 mm
- Misure vasca 810 × 400 mm
- Profondità vasca 220 mm
- Piletta automatica Plus 3 1/2"
- Base 900 mm



Cod. **ALG I 81**
Cod. **ALGG 81**

Foro miscelatore:
specificare fori extra
in fase di ordine.

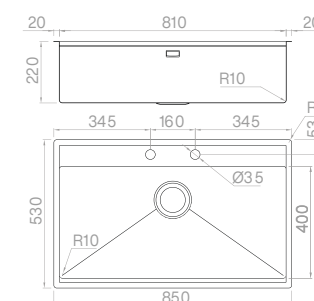

Accessori



Vedi pag. 49 per tutti gli accessori dedicati.

NEWGO 70

READY

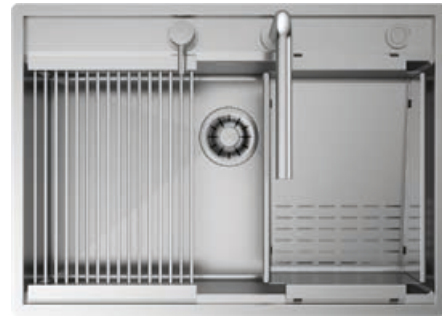

- Griglia
- Vaschetta inclinata forata
- Miscelatore Circle

- 12
- 23
- 45



Cod. **SAG I 70**
Cod. **SAGG 70**

NEWGO 70

PRO



- Supporto grigliato

- 12



Cod. **SBG I 70**
Cod. **SBGG 70**

NEWGO 70

SOLO



- | | |
|-------------------------|---------------|
| Materiale | AISI 304 |
| Finitura | Spazzolato |
| Raggio interno | Saldato 10 mm |
| Misure esterne | 740 × 530 mm |
| Misure vasca | 700 × 400 mm |
| Profondità vasca | 220 mm |
| Piletta automatica Plus | 3 ½" |
| Base | 800 mm |



Cod. **ALG I 70**
Cod. **ALGG 70**

Foro miscelatore:
specificare fori extra
in fase di ordine.

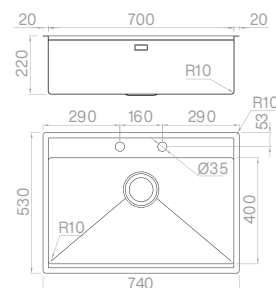

Accessori

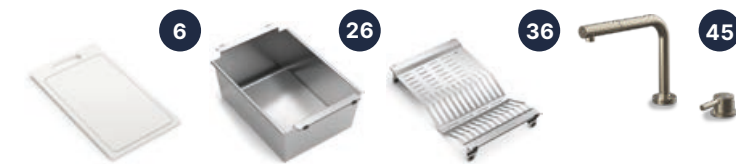

Vedi pag. 49 per tutti gli accessori dedicati.

NEWGO 65

READY



- Griglia
- Vaschetta inclinata forata
- Miscelatore Circle

- 12
- 23
- 45



Cod. **SAG I 65**
Cod. **SAGG 65**

NEWGO 65

PRO

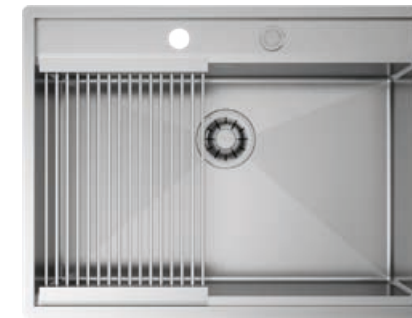

- Griglia

- 12



Cod. **SBG I 65**
Cod. **SBGG 65**

NEWGO 65

SOLO



- | | |
|-------------------------|---------------|
| Materiale | AISI 304 |
| Finitura | Spazzolato |
| Raggio interno | Saldato 10 mm |
| Misure esterne | 690 × 530 mm |
| Misure vasca | 650 × 400 mm |
| Profondità vasca | 220 mm |
| Piletta automatica Plus | 3 ½" |
| Base | 750 mm |



Cod. **ALG I 65**
Cod. **ALGG 65**

Foro miscelatore:
specificare fori extra
in fase di ordine.

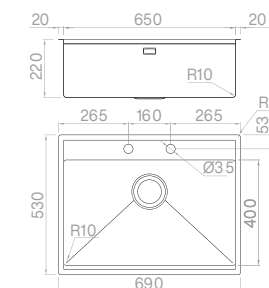

Accessori

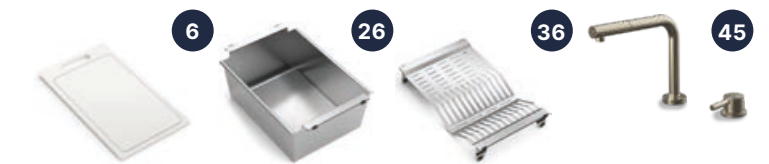

Vedi pag. 49 per tutti gli accessori dedicati.

Tagliere in legno**3**300×420×20 mm
Cod. **TRIB 3042****Tagliere in HDPE****6**240×420×20 mm
Cod. **TRP 2442****Griglia****12**250×420×25 mm
Cod. **GRS 2542****Set vaschetta forata****16**210×420×60 mm
Cod. **VQSF 2142****Vaschetta forata inclinata****23**280×420×110/60 mm
Cod. **VQSI 2842****Vaschetta****26**280×420×160 mm
Cod. **VQSP 2842****Set gastronorm****30**240×420×100 mm
Cod. **TI 2442 V****Set scolapasta****32**240×420×100 mm
Cod. **TI 2442 1S****Set grattugie****34**200×420×20 mm
Cod. **TI 2442 PG****Porta piatti****36**250×420×55 mm
Cod. **PPPB V400**

LAYER



LAYER BRL

Un'estetica essenziale e funzionale grazie all'ampia profondità che aumenta la capienza.
Tutto è contenuto all'interno dello spazio e ogni accessorio scorre perfettamente allineato al piano di lavoro.



LAYER BRL 104 **READY**



- Tagliere in legno
- Vaschetta forata
- Griglia
- Miscelatore Element

- 4
- 48
- 14
- 40



Cod. **SA BRL I 10**
Cod. **SA BRLO 10**

LAYER BRL 74 **READY**



- Tagliere in legno
- Vaschetta forata
- Miscelatore Element

- 4
- 48
- 40



Cod. **SA BRL I 74**
Cod. **SA BRLO 74**

LAYER BRL 104 **PRO**



- Tagliere in legno
- Vaschetta forata

- 4
- 48



Cod. **SB BRL I 10**
Cod. **SB BRLO 10**

LAYER BRL 74 **PRO**



- Tagliere in legno

- 4



Cod. **SB BRL I 74**
Cod. **SB BRLO 74**

LAYER BRL 104 **SOLO**



- | | |
|------------------|---------------|
| Materiale | AISI 304 |
| Finitura | Spazzolato |
| Raggio interno | Raggio '0' |
| Misure esterne | 1080 × 510 mm |
| Misure vasca | 960 × 410 mm |
| Profondità vasca | 230 mm |
| Piletta Plus | 3 ½" |
| Base | 1200 mm |



Cod. **AL BRL I 10**
Cod. **AL BRLO 10**

LAYER BRL 74 **SOLO**



- | | |
|------------------|--------------|
| Materiale | AISI 304 |
| Finitura | Spazzolato |
| Raggio interno | Raggio '0' |
| Misure esterne | 780 × 510 mm |
| Misure vasca | 660 × 410 mm |
| Profondità vasca | 230 mm |
| Piletta Plus | 3 ½" |
| Base | 900 mm |



Cod. **AL BRL I 74**
Cod. **AL BRLO 74**

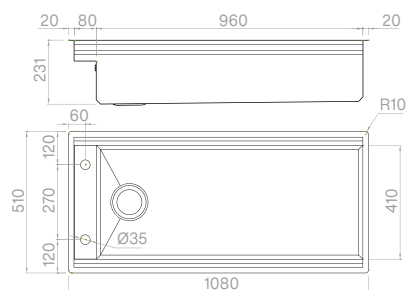

Accessori

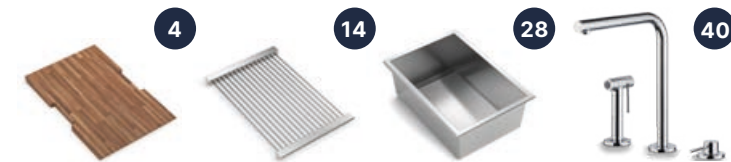

Vedi pag. 57 per tutti gli accessori dedicati.

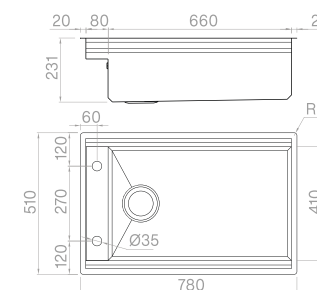

Accessori

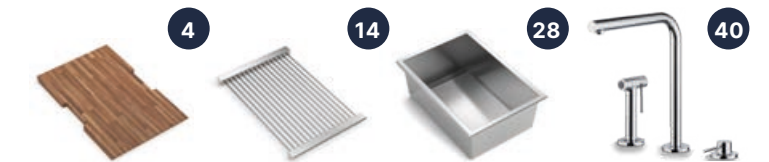

Vedi pag. 57 per tutti gli accessori dedicati.

Tagliere in legno**4**

345×465×25 mm

Cod. **TBRL 4634****Griglia****14**

300×465×25 mm

Cod. **GFL 4630****Vaschetta forata****21**

190×435×80 mm

Cod. **VFPB RL19****Vaschetta****28**

345×435×160 mm

Cod. **VGB RL34****Vaschetta forata****48**

345×435×80 mm

Cod. **VFGB RL34**

LAYER BRP

Un design esclusivo, con un sistema di involucri inclinati dove accessori dedicati scorrono su due livelli. Il più alto è dedicato a griglie e taglieri mentre, appena sotto, trovano posizione vaschette e contenitori, ottenendo la massima funzionalità.



LAYER BRP 104

READY



- Tagliere in legno
- Vaschetta forata
- Griglia
- Miscelatore Element

- 5
- 49
- 15
- 40

 Sopratop

Cod. **SA BRP 104**

LAYER BRP 104

PRO



- Tagliere in legno
- Vaschetta forata

- 5
- 49

 Sopratop

Cod. **SB BRP 104**

LAYER BRP 104

SOLO



Materiale	AISI 304
Finitura	Spazzolato
Raggio interno	Raggio '0'
Misure esterne	1080 × 510 mm
Misure vasca	1040 × 350 mm
Profondità vasca	210 mm
Piletta Plus	3 1/2"
Base	1200 mm

 Sopratop

Cod. **AL BRP 104**

Foro miscelatore:
specificare fori
extra in fase di
ordine.

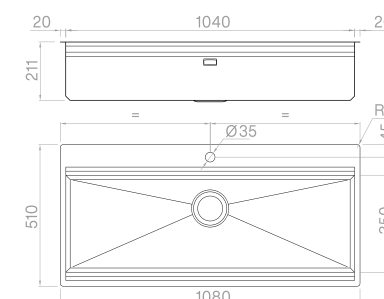

Accessori



Vedi pag. 75 per tutti gli accessori dedicati.

LAYER BRP 81

READY



- Tagliere in legno
- Vaschetta forata
- Griglia
- Miscelatore Vertigo

- 5
- 49
- 15
- 47



Cod. **SA BRP 81**

LAYER BRP 70

READY



- Tagliere in legno
- Vaschetta forata
- Griglia
- Miscelatore Vertigo

- 5
- 22
- 15
- 47



Cod. **SA BRP 70**

LAYER BRP 81

PRO



- Tagliere in legno
- Vaschetta forata

- 5
- 49



Cod. **SB BRP 81**

LAYER BRP 70

PRO



- Tagliere in legno
- Vaschetta forata

- 5
- 22



Cod. **SB BRP 70**

LAYER BRP 81

SOLO



Materiale	AISI 304
Finitura	Spazzolato
Raggio interno	Raggio '0'
Misure esterne	860 × 510 mm
Misure vasca	810 × 350 mm
Profondità vasca	210 mm
Piletta Plus	3 ½"
Base	900 mm



Cod. **AL BRP 81**

LAYER BRP 70

SOLO



Materiale	AISI 304
Finitura	Spazzolato
Raggio interno	Raggio '0'
Misure esterne	740 × 510 mm
Misure vasca	700 × 350 mm
Profondità vasca	210 mm
Piletta Plus	3 ½"
Base	800 mm



Cod. **AL BRP 70**

Foro miscelatore:
specificare fori extra
in fase di ordine.

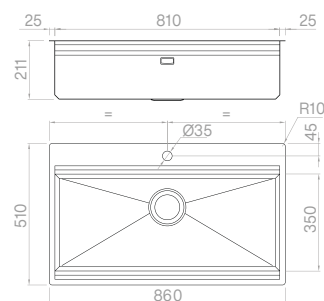

Accessori

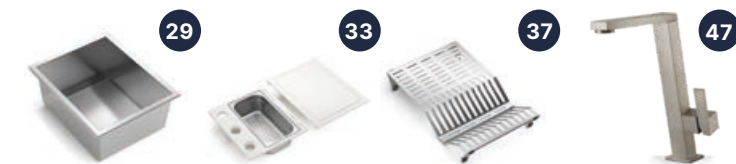

Vedi pag. 75 per tutti gli accessori dedicati.

Foro miscelatore:
specificare fori extra
in fase di ordine.

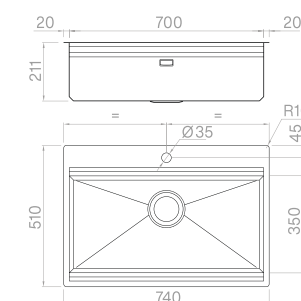

Accessori

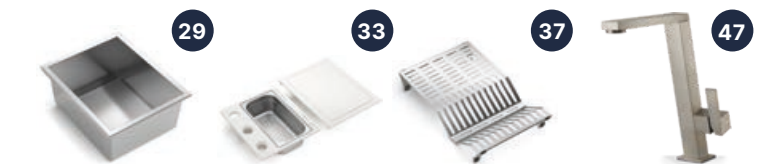

Vedi pag. 75 per tutti gli accessori dedicati.

LAYER BRP 65

READY



Tagliere in legno
Vaschetta forata
Miscelatore Vertigo

5
22
47



Cod. SA BRP 65

LAYER BRP 65

PRO



Tagliere in legno

5



Cod. SB BRP 65

LAYER BRP 65

SOLO



Materiale	AISI 304
Finitura	Spazzolato
Raggio interno	Raggio '0'
Misure esterne	690 × 510 mm
Misure vasca	650 × 350 mm
Profondità vasca	210 mm
Piletta Plus	3 ½"
Base	750 mm



Cod. AL BRP 65

Foro miscelatore:
specificare fori extra
in fase di ordine.

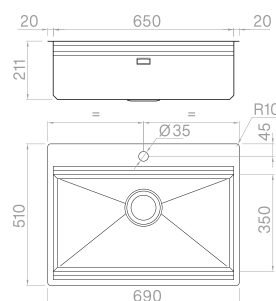

Accessori

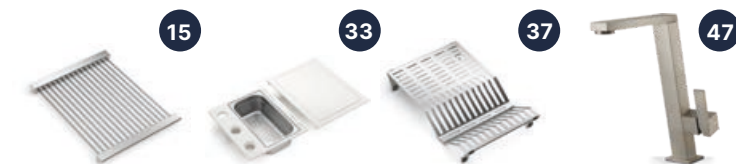

Vedi pag. 75 per tutti gli accessori dedicati.

LAYER BRP 50

READY



Tagliere in legno
Vaschetta forata
Miscelatore Vertigo

5
22
47



Cod. SA BRP 50

LAYER BRP 50

PRO



Tagliere in legno

5



Cod. SB BRP 50

LAYER BRP 50

SOLO



Materiale	AISI 304
Finitura	Spazzolato
Raggio interno	Raggio '0'
Misure esterne	540 × 510 mm
Misure vasca	500 × 350 mm
Profondità vasca	210 mm
Piletta Plus	3 ½"
Base	600 mm



Cod. AL BRP 50

Foro miscelatore:
specificare fori extra
in fase di ordine.

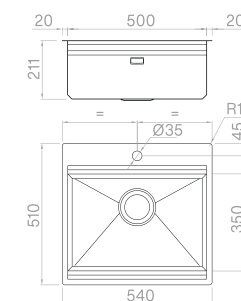

Accessori



Vedi pag. 75 per tutti gli accessori dedicati.

LAYER SP



Il design esclusivo di Layer SP è definito da linee pure caratterizzate da un funzionale sportello sul fondo che cela lo scarico al suo interno.

LAYER SP 81

READY



- Tagliere in legno
- Vaschetta forata
- Griglia
- Miscelatore Hero

- 5
- 49
- 15
- 39



Cod. **SA BR81 SP**

LAYER SP 70

READY



- Tagliere in legno
- Vaschetta forata
- Griglia
- Miscelatore Hero

- 5
- 22
- 15
- 39



Cod. **SA BR70 SP**

LAYER SP 81

PRO



- Tagliere in legno
- Vaschetta forata

- 5
- 49



Cod. **SB BR81 SP**

LAYER SP 70

PRO



- Tagliere in legno
- Vaschetta forata

- 5
- 22



Cod. **SB BR70 SP**

LAYER SP 81

SOLO



Materiale	AISI 304
Finitura	Spazzolato
Raggio interno	Raggio '0'
Misure esterne	860 × 510 mm
Misure vasca	810 × 350 mm
Profondità vasca	210 mm
Piletta automatica	3 ½"
Base	900 mm



Cod. **AL BR81 SP**

LAYER SP 70

SOLO



Materiale	AISI 304
Finitura	Spazzolato
Raggio interno	Raggio '0'
Misure esterne	740 × 510 mm
Misure vasca	700 × 350 mm
Profondità vasca	210 mm
Piletta automatica	3 ½"
Base	800 mm



Cod. **AL BR70 SP**

Foro miscelatore:
specificare fori extra
in fase di ordine.

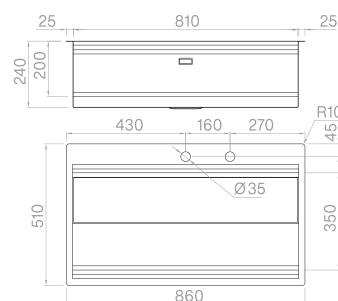

Accessori

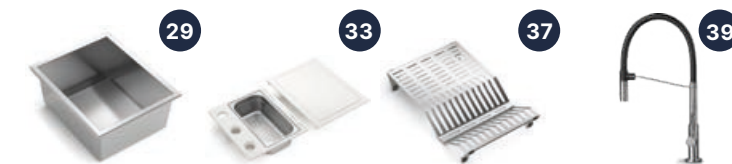

Vedi pag. 75 per tutti gli accessori dedicati.

Foro miscelatore:
specificare fori extra
in fase di ordine.

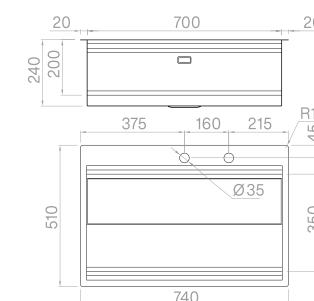

Accessori



Vedi pag. 75 per tutti gli accessori dedicati.

LAYER SBR

Una workstation icona grazie a taglieri, vassoi e tanti speciali accessori scorrevoli che permettono un'area di lavoro funzionale e personalizzabile in infinite possibilità.



LAYER SBR 104

READY



- Tagliere in legno
- Vaschetta forata
- Griglia
- Miscelatore Element

- 5
- 49
- 15
- 40

- Sopratop
- Sottotop

Cod. **SA SBR 104**
Cod. **SA SBR ST1**

LAYER SBR 104

PRO



- Tagliere in legno
- Vaschetta forata

- 5
- 49

- Sopratop
- Sottotop

Cod. **SB SBR 104**
Cod. **SB SBR ST1**

LAYER SBR 104

SOLO



- | | |
|------------------|---------------|
| Materiale | AISI 304 |
| Finitura | Spazzolato |
| Raggio interno | Raggio '0' |
| Misure esterne | 1080 x 450 mm |
| Misure vasca | 1040 x 350 mm |
| Profondità vasca | 210 mm |
| Piletta Plus | 3 1/2" |
| Base | 1200 mm |

- Sopratop
- Sottotop

Cod. **SBR 104**
Cod. **SBR ST 104**

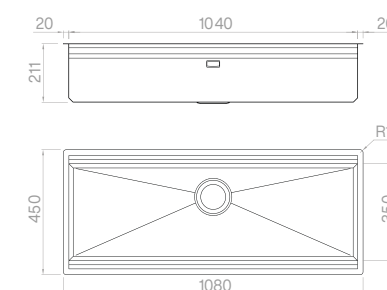

Accessori



Vedi pag. 75 per tutti gli accessori dedicati.

LAYER SBR 81 **READY**



- Tagliere in legno
- Vaschetta forata
- Griglia
- Miscelatore Vertigo

- 5
- 49
- 15
- 47



Cod. **SA SBR 81**
Cod. **SA SBR ST8**

LAYER SBR 70 **READY**



- Tagliere in legno
- Vaschetta forata
- Griglia
- Miscelatore Vertigo

- 5
- 22
- 15
- 47



Cod. **SA SBR 70**
Cod. **SA SBR ST7**

LAYER SBR 81 **PRO**



- Tagliere in legno
- Vaschetta forata

- 5
- 49



Cod. **SB SBR 81**
Cod. **SB SBR ST8**

LAYER SBR 70 **PRO**



- Tagliere in legno
- Vaschetta forata

- 5
- 22



Cod. **SB SBR 70**
Cod. **SB SBR ST7**

LAYER SBR 81 **SOLO**



Materiale	AISI 304
Finitura	Spazzolato
Raggio interno	Raggio '0'
Misure esterne	850 × 450 mm
Misure vasca	810 × 350 mm
Profondità vasca	210 mm
Piletta Plus	3 ½"
Base	900 mm



Cod. **SBR 81**
Cod. **SBR ST 81**

LAYER SBR 70 **SOLO**



Materiale	AISI 304
Finitura	Spazzolato
Raggio interno	Raggio '0'
Misure esterne	740 × 450 mm
Misure vasca	700 × 350 mm
Profondità vasca	210 mm
Piletta Plus	3 ½"
Base	800 mm



Cod. **SBR 70**
Cod. **SBR ST 70**

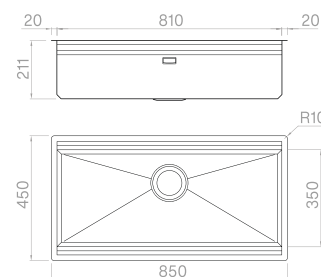

Accessori

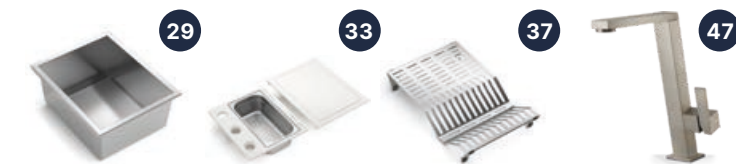

Vedi pag. 75 per tutti gli accessori dedicati.

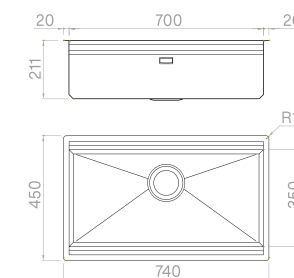

Accessori



Vedi pag. 75 per tutti gli accessori dedicati.

LAYER SBR 65 **READY**



Tagliere in legno
Vaschetta forata
Miscelatore Vertigo

5
22
47



Cod. **SA SBR 65**
Cod. **SA SBR ST6**

LAYER SBR 65 **PRO**



Tagliere in legno

5



Cod. **SB SBR 65**
Cod. **SB SBR ST6**

LAYER SBR 65 **SOLO**



Materiale	AISI 304
Finitura	Spazzolato
Raggio interno	Raggio '0'
Misure esterne	690 × 450 mm
Misure vasca	650 × 350 mm
Profondità vasca	210 mm
Piletta Plus	3 ½"
Base	750 mm



Cod. **SBR 65**
Cod. **SBR ST 65**

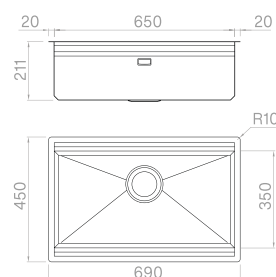

Accessori

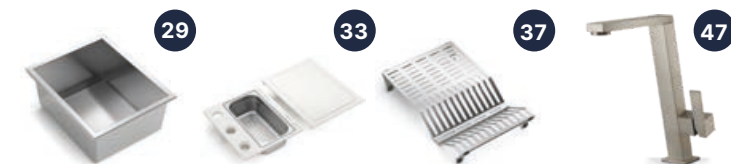

Vedi pag. 75 per tutti gli accessori dedicati.

LAYER SBR 50 **READY**



Tagliere in legno
Vaschetta forata
Miscelatore Vertigo

5
22
47



Cod. **SA SBR 50**
Cod. **SA SBR ST5**

LAYER SBR 50 **PRO**



Tagliere in legno

5



Cod. **SB SBR 50**
Cod. **SB SBR ST5**

LAYER SBR 50 **SOLO**



Materiale	AISI 304
Finitura	Spazzolato
Raggio interno	Raggio '0'
Misure esterne	540 × 450 mm
Misure vasca	500 × 350 mm
Profondità vasca	210 mm
Piletta Plus	3 ½"
Base	600 mm



Cod. **SBR 50**
Cod. **SBR ST 50**

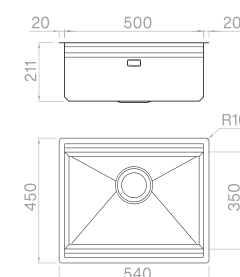

Accessori



Vedi pag. 75 per tutti gli accessori dedicati.

Tagliere in legno**5**300×405×25 mm
Cod. **TSBR 4030****Griglia****15**300×405×25 mm
Cod. **GFL 4030****Vaschetta forata****22**190×375×80 mm
Cod. **VFP SBR19****Vaschetta****29**300×375×160 mm
Cod. **VGS BR34****Set tagliere + gastronorm****31**300×405×100 mm
Cod. **TPLB 3V****Set tagliere + colapasta****33**300×405×100 mm
Cod. **TPLB 1S****Set tagliere + telaio porta coltelli****35**300×405×20 mm
Cod. **TPLB 4030****Porta piatti****37**250×400×55 mm
Cod. **PPPB SBR****Vaschetta forata****49**300×375×80 mm
Cod. **VFG SBR34**

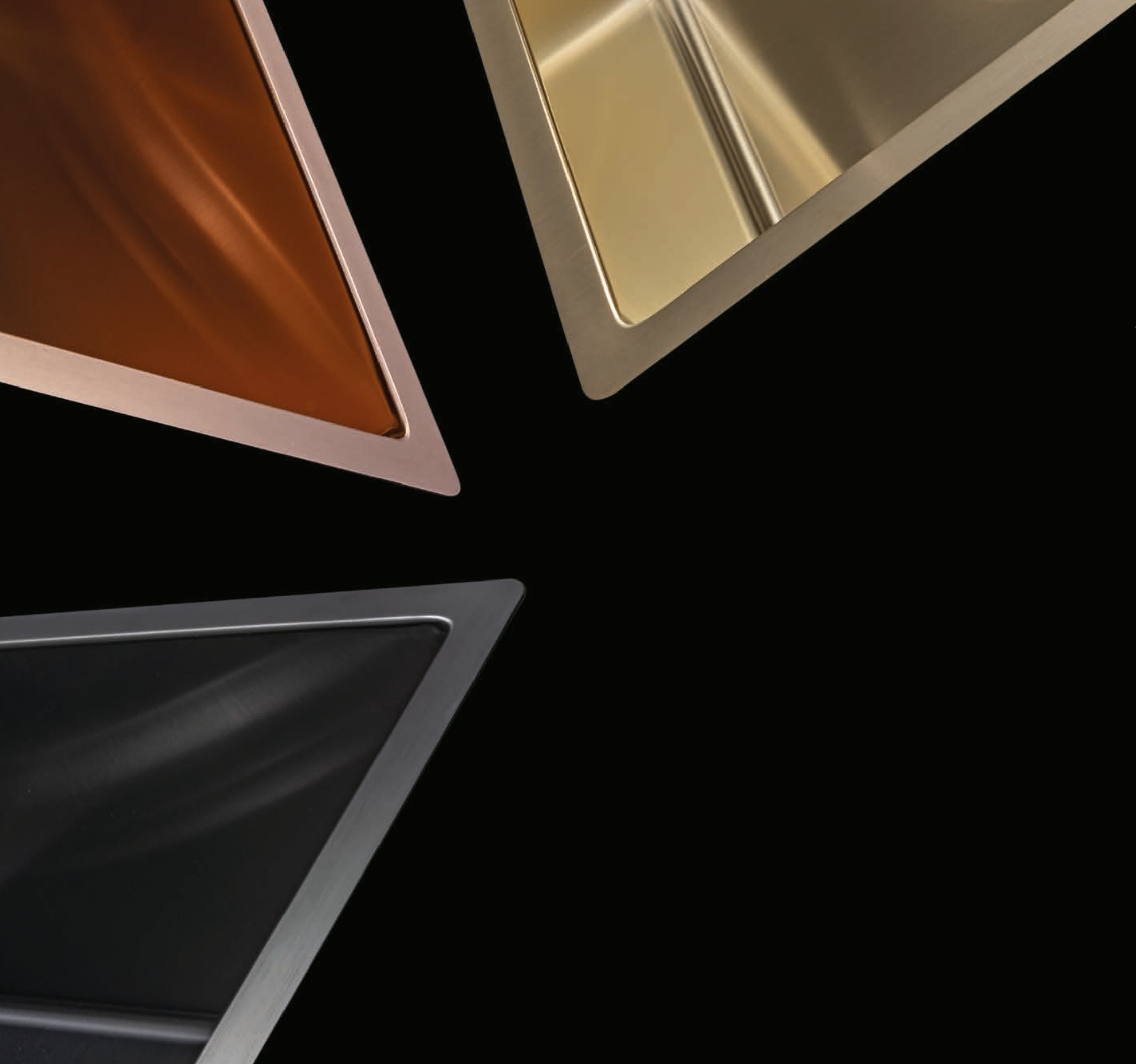

TITANIUM

Lo speciale trattamento PVD è una tecnologia atossica e resistente che permette di virare il colore dell'acciaio inox.

Nelle tre finiture esclusive Artinox – Gun Metal, Copper Bronze e Pale Gold – sono applicate soluzioni monocromatiche dall'altissimo impatto estetico.

TITANIUM GUN METAL



TITANIUM 70 GUN METAL

READY

Vaschetta forata Gun Metal
Miscelatore Athom

17
42

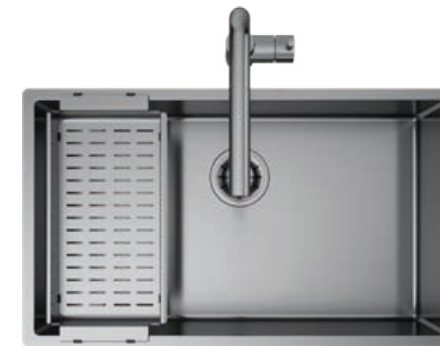

- Sopratop
- Filotop
- Sottotop

Cod. **SAT I 70 RA**
Cod. **SATG 70 RA**
Cod. **SATO 70 RA**

TITANIUM 70 GUN METAL

PRO

Vaschetta forata Gun Metal

17



- Sopratop
- Filotop
- Sottotop

Cod. **SBT I 70 RA**
Cod. **SBTG 70 RA**
Cod. **SBTO 70 RA**

TITANIUM 70 GUN METAL

SOLO



Materiale	AISI 304
Finitura	PVD Gun Metal
Raggio interno	Saldato 10 mm
Misure esterne	740 × 440 mm
Misure vasca	700 × 400 mm
Profondità vasca	200 mm
Piletta Plus Gun Metal	3 1/2"
Base	800 mm
Sopratop	Cod. TI 7040 RA
Filotop	Cod. TG 7040 RA
Sottotop	Cod. TO 7040 RA

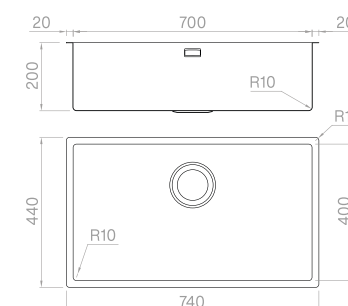

Accessori



Vedi pag. 91 per tutti gli accessori dedicati.

TITANIUM 50 GUN METAL

READY

Vaschetta forata Gun Metal
Miscelatore Athom

17
42



- Sopratop
- Filotop
- Sottotop

Cod. **SAT I 50 RA**
Cod. **SATG 50 RA**
Cod. **SATO 50 RA**

TITANIUM 40 GUN METAL

READY

Vaschetta forata Gun Metal
Miscelatore Athom

17
42



- Sopratop
- Filotop
- Sottotop

Cod. **SAT I 40 RA**
Cod. **SATG 40 RA**
Cod. **SATO 40 RA**

TITANIUM 50 GUN METAL

PRO

Vaschetta forata Gun Metal

17



- Sopratop
- Filotop
- Sottotop

Cod. **SBT I 50 RA**
Cod. **SBTG 50 RA**
Cod. **SBTO 50 RA**

TITANIUM 40 GUN METAL

PRO

Vaschetta forata Gun Metal

17



- Sopratop
- Filotop
- Sottotop

Cod. **SBT I 40 RA**
Cod. **SBTG 40 RA**
Cod. **SBTO 40 RA**

TITANIUM 50 GUN METAL

SOLO

Materiale	AISI 304
Finitura	PVD Gun Metal
Raggio interno	Saldato 10 mm
Misure esterne	540 × 440 mm
Misure vasca	500 × 400 mm
Profondità vasca	200 mm
Piletta Plus Gun Metal	3 ½"
Base	600 mm

- Sopratop
- Filotop
- Sottotop

Cod. **TI 5040 RA**
Cod. **TG 5040 RA**
Cod. **TO 5040 RA**



TITANIUM 40 GUN METAL

SOLO

Materiale	AISI 304
Finitura	PVD Gun Metal
Raggio interno	Saldato 10 mm
Misure esterne	440 × 440 mm
Misure vasca	400 × 400 mm
Profondità vasca	200 mm
Piletta Plus Gun Metal	3 ½"
Base	600 mm

- Sopratop
- Filotop
- Sottotop

Cod. **TI 4040 RA**
Cod. **TG 4040 RA**
Cod. **TO 4040 RA**

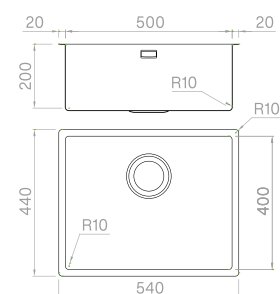

Accessori



Vedi pag. 91 per tutti gli accessori dedicati.

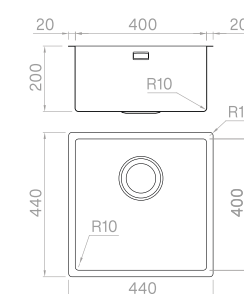

Accessori



Vedi pag. 91 per tutti gli accessori dedicati.

TITANIUM COPPER BRONZE



TITANIUM 70 COPPER BRONZE

READY

Vaschetta forata Copper Bronze **18**
 Miscelatore Athom **43**

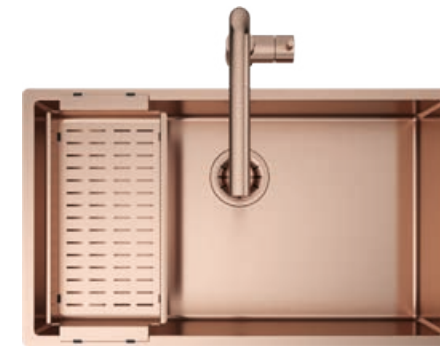

 Sopratop
 Filotop
 Sottotop



Cod. **SAT I 70 RC**
 Cod. **SATG 70 RC**
 Cod. **SATO 70 RC**

TITANIUM 70 COPPER BRONZE

PRO

Vaschetta forata Copper Bronze **18**



 Sopratop
 Filotop
 Sottotop



Cod. **SBT I 70 RC**
 Cod. **SBTG 70 RC**
 Cod. **SBTO 70 RC**

TITANIUM 70 COPPER BRONZE

SOLO

Materiale	AISI 304
Finitura	PVD Copper Bronze
Raggio interno	Saldato 10 mm
Misure esterne	740 × 440 mm
Misure vasca	700 × 400 mm
Profondità vasca	200 mm
Piletta Plus Copper Bronze	3 ½"
Base	800 mm



 Sopratop
 Filotop
 Sottotop

Cod. **TI 7040 RC**
 Cod. **TG 7040 RC**
 Cod. **TO 7040 RC**

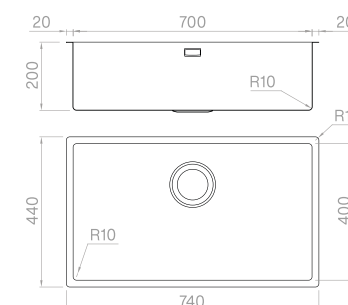

Accessori



Vedi pag. 91 per tutti gli accessori dedicati.

TITANIUM 50 COPPER BRONZE

READY



Vaschetta forata Copper Bronze
Miscelatore Athom

18
43

- Sopratop
- Filotop
- Sottotop

Cod. **SAT I 50 RC**
Cod. **SATG 50 RC**
Cod. **SATO 50 RC**

TITANIUM 50 COPPER BRONZE

PRO



Vaschetta forata Copper Bronze

18

- Sopratop
- Filotop
- Sottotop

Cod. **SBT I 50 RC**
Cod. **SBTG 50 RC**
Cod. **SBTO 50 RC**

TITANIUM 50 COPPER BRONZE

SOLO



Materiale	AISI 304
Finitura	PVD Copper Bronze
Raggio interno	Saldato 10 mm
Misure esterne	540 × 440 mm
Misure vasca	500 × 400 mm
Profondità vasca	200 mm
Piletta Plus Copper Bronze	3 ½"
Base	600 mm

- Sopratop
- Filotop
- Sottotop

Cod. **TI 5040 RC**
Cod. **TG 5040 RC**
Cod. **TO 5040 RC**

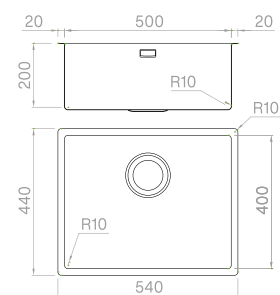

Accessori



Vedi pag. 91 per tutti gli accessori dedicati.

TITANIUM 40 COPPER BRONZE

READY



Vaschetta forata Copper Bronze
Miscelatore Athom

18
43

- Sopratop
- Filotop
- Sottotop

Cod. **SAT I 40 RC**
Cod. **SATG 40 RC**
Cod. **SATO 40 RC**

TITANIUM 40 COPPER BRONZE

PRO



Vaschetta forata Copper Bronze

18

- Sopratop
- Filotop
- Sottotop

Cod. **SBT I 40 RC**
Cod. **SBTG 40 RC**
Cod. **SBTO 40 RC**

TITANIUM 40 COPPER BRONZE

SOLO

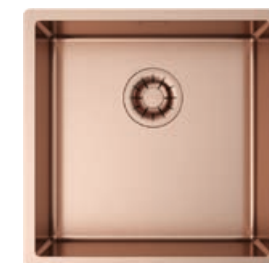

Materiale	AISI 304
Finitura	PVD Copper Bronze
Raggio interno	Saldato 10 mm
Misure esterne	440 × 440 mm
Misure vasca	400 × 400 mm
Profondità vasca	200 mm
Piletta Plus Copper Bronze	3 ½"
Base	600 mm

- Sopratop
- Filotop
- Sottotop

Cod. **TI 4040 RC**
Cod. **TG 4040 RC**
Cod. **TO 4040 RC**

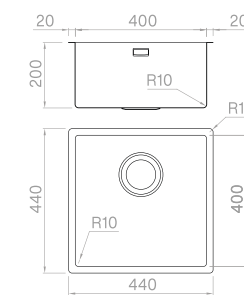

Accessori



Vedi pag. 91 per tutti gli accessori dedicati.

TITANIUM PALE GOLD



TITANIUM 70 PALE GOLD

READY

Vaschetta forata Pale Gold
Miscelatore Athom

19
44

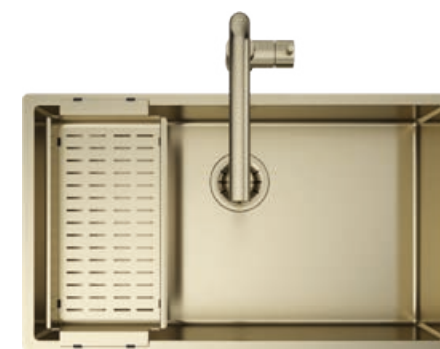

Sopratop
Filotop
Sottotop

Cod. **SAT I 70 RG**
Cod. **SATG 70 RG**
Cod. **SATO 70 RG**

TITANIUM 70 PALE GOLD

PRO

Vaschetta forata Pale Gold

19



Sopratop
Filotop
Sottotop

Cod. **SBT I 70 RG**
Cod. **SBTG 70 RG**
Cod. **SBTO 70 RG**

TITANIUM 70 PALE GOLD

SOLO

Materiale	AISI 304
Finitura	PVD Pale Gold
Raggio interno	Saldato 10 mm
Misure esterne	740 × 440 mm
Misure vasca	700 × 400 mm
Profondità vasca	200 mm
Piletta Plus Pale Gold	3 1/2"
Base	800 mm



Sopratop
Filotop
Sottotop

Cod. **TI 7040 RG**
Cod. **TG 7040 RG**
Cod. **TO 7040 RG**

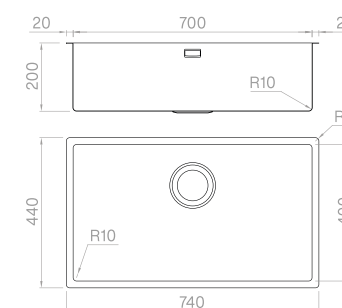

Accessori



Vedi pag. 91 per tutti gli accessori dedicati.

TITANIUM 50 PALE GOLD

READY



Vaschetta forata Pale Gold
Miscelatore Athom

19
44

- Sopratop
- Filotop
- Sottotop

Cod. **SAT I 50 RG**
Cod. **SATG 50 RG**
Cod. **SATO 50 RG**

TITANIUM 40 PALE GOLD

READY



Vaschetta forata Pale Gold
Miscelatore Athom

19
44

- Sopratop
- Filotop
- Sottotop

Cod. **SAT I 40 RG**
Cod. **SATG 40 RG**
Cod. **SATO 40 RG**

TITANIUM 50 PALE GOLD

PRO



Vaschetta forata Pale Gold

19

- Sopratop
- Filotop
- Sottotop

Cod. **SBT I 50 RG**
Cod. **SBTG 50 RG**
Cod. **SBTO 50 RG**

TITANIUM 40 PALE GOLD

PRO

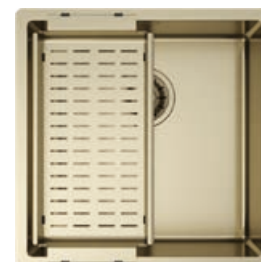

Vaschetta forata Pale Gold

19

- Sopratop
- Filotop
- Sottotop

Cod. **SBT I 40 RG**
Cod. **SBTG 40 RG**
Cod. **SBTO 40 RG**

TITANIUM 50 PALE GOLD

SOLO



Materiale	AISI 304
Finitura	PVD Pale Gold
Raggio interno	Saldato 10 mm
Misure esterne	540 × 440 mm
Misure vasca	500 × 400 mm
Profondità vasca	200 mm
Piletta Plus Pale Gold	3 ½"
Base	600 mm

- Sopratop
- Filotop
- Sottotop

Cod. **TI 5040 RG**
Cod. **TG 5040 RG**
Cod. **TO 5040 RG**

TITANIUM 40 PALE GOLD

SOLO

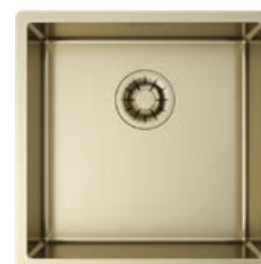

Materiale	AISI 304
Finitura	PVD Pale Gold
Raggio interno	Saldato 10 mm
Misure esterne	440 × 440 mm
Misure vasca	400 × 400 mm
Profondità vasca	200 mm
Piletta Plus Pale Gold	3 ½"
Base	600 mm

- Sopratop
- Filotop
- Sottotop

Cod. **TI 4040 RG**
Cod. **TG 4040 RG**
Cod. **TO 4040 RG**

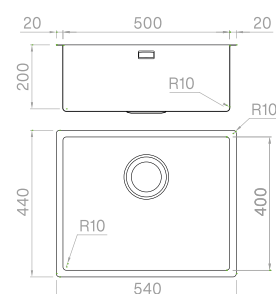

Accessori



Vedi pag. 91 per tutti gli accessori dedicati.

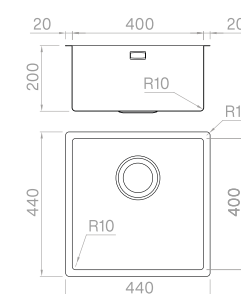

Accessori



Vedi pag. 91 per tutti gli accessori dedicati.

**Tagliere in legno****3**

300×420×20 mm
Cod. **TRIB 3042**

**Tagliere in HDPE****6**

240×420×20 mm
Cod. **TRP 2442**

**Vaschetta forata Gun Metal****17**

210×420×60 mm
Cod. **VQAF 2142**

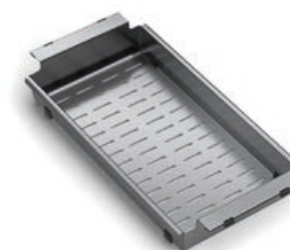
**Vaschetta forata Copper Bronze****18**

210×420×60 mm
Cod. **VQCF 2142**

**Vaschetta forata Pale Gold****19**

210×420×60 mm
Cod. **VQGF 2142**

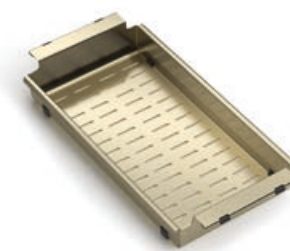
**Set gastronorm****30**

240×420×100 mm
Cod. **TI 2442 V**

**Set scolapasta****32**

240×420×100 mm
Cod. **TI 2442 1S**

**Set grattugie****34**

200×420×20 mm
Cod. **TI 2442 PG**



RADIUS



RADIUS MATTE VINTAGE

Un lavello elegante e sofisticato grazie all'abbinamento fra l'acciaio Matte Vintage e la finitura nera dei miscelatori e degli accessori.

Il Matte Vintage è un'esclusiva Artinox caratterizzata da una superficie non uniforme che esalta la matericità dell'acciaio inossidabile.



RADIUS MATTE VINTAGE 70

READY



Griglia
Vaschetta inclinata forata
Miscelatore Ergo

13
24
41

Sopratop
 Filotop
 Sottotop

Cod. **SAB I 70 RH**
 Cod. **SABG 70 RH**
 Cod. **SABO 70 RH**

RADIUS MATTE VINTAGE 70

PRO



Vaschetta inclinata forata

24

Sopratop
 Filotop
 Sottotop

Cod. **SBB I 70 RH**
 Cod. **SBBG 70 RH**
 Cod. **SBBO 70 RH**

RADIUS MATTE VINTAGE 70

SOLO



Materiale	AISI 304
Finitura	Spazzolato opaco
Raggio interno	Saldato 10 mm
Misure esterne	740 × 440 mm
Misure vasca	700 × 400 mm
Profondità vasca	200 mm
Piletta nera	3 ½"
Base	800 mm

Sopratop
 Filotop
 Sottotop

Cod. **BI 7040 RH**
 Cod. **BG 7040 RH**
 Cod. **BO 7040 RH**

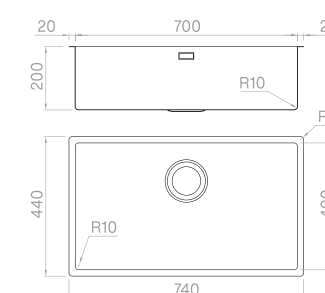

Accessori



Vedi pag. 99 per tutti gli accessori dedicati.

RADIUS MATTE VINTAGE 50

READY

Vaschetta inclinata forata
Miscelatore Ergo

24
41



Cod. **SAB I 50 RH**
Cod. **SABG 50 RH**
Cod. **SABO 50 RH**

RADIUS MATTE VINTAGE 50

PRO

Vaschetta inclinata forata

24



Cod. **SBB I 50 RH**
Cod. **SBBG 50 RH**
Cod. **SBBO 50 RH**

RADIUS MATTE VINTAGE 50

SOLO

Materiale	AISI 304
Finitura	Spazzolato opaco
Raggio interno	Saldato 10 mm
Misure esterne	540 × 440 mm
Misure vasca	500 × 400 mm
Profondità vasca	200 mm
Piletta nera	3 ½"
Base	600 mm

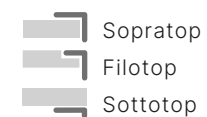

Cod. **BI 5040 RH**
Cod. **BG 5040 RH**
Cod. **BO 5040 RH**

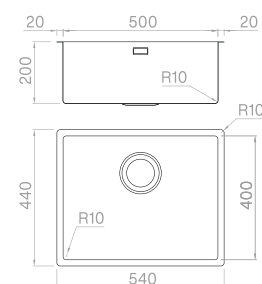

Accessori

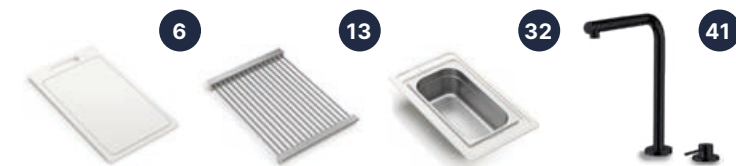

Vedi pag. 99 per tutti gli accessori dedicati.

RADIUS MATTE VINTAGE 40

READY

Vaschetta inclinata forata
Miscelatore Ergo

24
41



Cod. **SAB I 40 RH**
Cod. **SABG 40 RH**
Cod. **SABO 40 RH**

RADIUS MATTE VINTAGE 40

PRO

Vaschetta inclinata forata

24



Cod. **SBB I 40 RH**
Cod. **SBBG 40 RH**
Cod. **SBBO 40 RH**

RADIUS MATTE VINTAGE 40

SOLO

Materiale	AISI 304
Finitura	Spazzolato opaco
Raggio interno	Saldato 10 mm
Misure esterne	440 × 440 mm
Misure vasca	400 × 400 mm
Profondità vasca	200 mm
Piletta nera	3 ½"
Base	600 mm

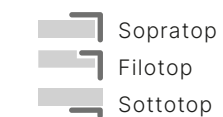

Cod. **BI 4040 RH**
Cod. **BG 4040 RH**
Cod. **BO 4040 RH**

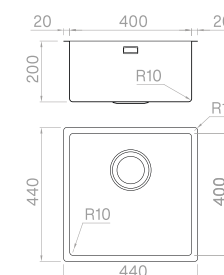

Accessori

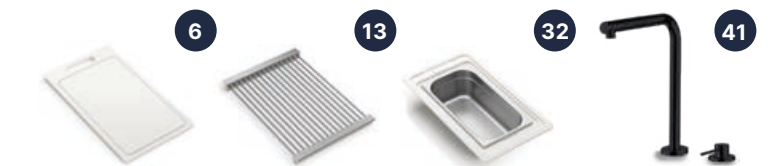

Vedi pag. 99 per tutti gli accessori dedicati.

Tagliere in legno**3**300×420×20 mm
Cod. **TRIB 3042****Tagliere in HDPE****6**240×420×20 mm
Cod. **TRP 2442****Griglia matte vintage****13**250×420×25 mm
Cod. **GRH 2542****Vaschetta inclinata forata matte vintage****24**280×420×110/60 mm
Cod. **VQHI 2842****Set gastronorm****30**240×420×100 mm
Cod. **TI 2442 V****Set scolapasta****32**240×420×100 mm
Cod. **TI 2442 1S****Set grattugie****34**200×420×20 mm
Cod. **TI 2442 PG**

RADIUS

La collezione Radius ha un'ampia scelta di lavelli, realizzati con angoli interni raggio 10 mm. La precisione si somma all'essenzialità delle geometrie.



RADIUS 81

READY



- Tagliere in legno
- Vaschetta inclinata forata
- Vaschetta
- Miscelatore Element

3
23
26
40

- Sopratop
- Filotop
- Sottotop

Cod. **SAB I 81 R1**
Cod. **SABG 81 R1**
Cod. **SABO 81 R1**

RADIUS 81

PRO



- Vaschetta forata

16

- Sopratop
- Filotop
- Sottotop

Cod. **SBB I 81 R1**
Cod. **SBBG 81 R1**
Cod. **SBBO 81 R1**

RADIUS 81

SOLO



- Materiale AISI 304
- Finitura Spazzolato
- Raggio interno Saldato 10 mm
- Misure esterne 850 × 440 mm
- Misure vasca 810 × 400 mm
- Profondità vasca 200 mm
- Piletta standard 3 1/2"
- Base 900 mm

- Sopratop
- Filotop
- Sottotop

Cod. **BI 8140 R1**
Cod. **BG 8140 R1**
Cod. **BO 8140 R1**

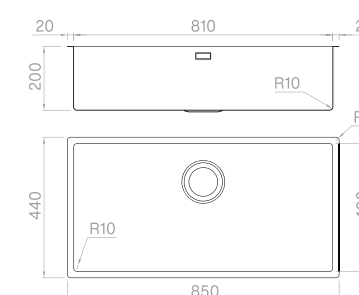

Accessori

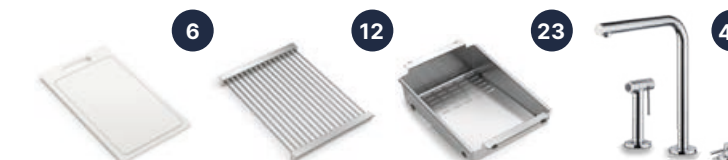

Vedi pag. 109 per tutti gli accessori dedicati.

RADIUS 70

READY



- Tagliere in legno
- Vaschetta inclinata forata
- Vaschetta
- Miscelatore Element

- 3
- 23
- 26
- 40

- Sopratop
- Filotop
- Sottotop

Cod. **SAB I 70 R1**
 Cod. **SABG 70 R1**
 Cod. **SABO 70 R1**

RADIUS 65

READY



- Tagliere in legno
- Vaschetta inclinata forata
- Miscelatore Hero

- 3
- 23
- 39

- Sopratop
- Filotop
- Sottotop

Cod. **SAB I 65 R1**
 Cod. **SABG 65 R1**
 Cod. **SABO 65 R1**

RADIUS 70

PRO



- Vaschetta forata

16

- Sopratop
- Filotop
- Sottotop

Cod. **SBB I 70 R1**
 Cod. **SBBG 70 R1**
 Cod. **SBBO 70 R1**

RADIUS 65

PRO



- Vaschetta forata

16

- Sopratop
- Filotop
- Sottotop

Cod. **SBB I 65 R1**
 Cod. **SBBG 65 R1**
 Cod. **SBBO 65 R1**

RADIUS 70

SOLO



- Materiale AISI 304
- Finitura Spazzolato
- Raggio interno Saldato 10 mm
- Misure esterne 740 × 440 mm
- Misure vasca 700 × 400 mm
- Profondità vasca 200 mm
- Piletta standard 3 ½"
- Base 800 mm

- Sopratop
- Filotop
- Sottotop

Cod. **BI 7040 R1**
 Cod. **BG 7040 R1**
 Cod. **BO 7040 R1**

RADIUS 65

SOLO



- Materiale AISI 304
- Finitura Spazzolato
- Raggio interno Saldato 10 mm
- Misure esterne 690 × 440 mm
- Misure vasca 650 × 400 mm
- Profondità vasca 200 mm
- Piletta standard 3 ½"
- Base 750 mm

- Sopratop
- Filotop
- Sottotop

Cod. **BI 6540 R1**
 Cod. **BG 6540 R1**
 Cod. **BO 6540 R1**

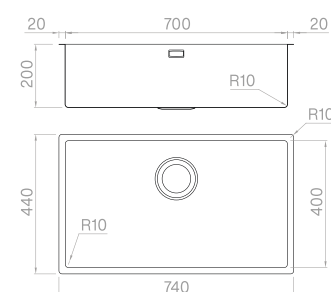

Accessori

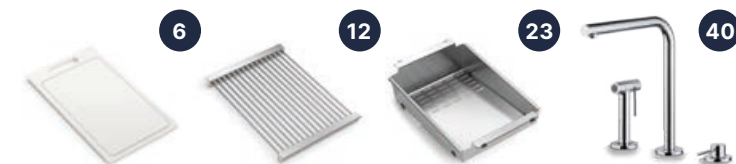

Vedi pag. 109 per tutti gli accessori dedicati.

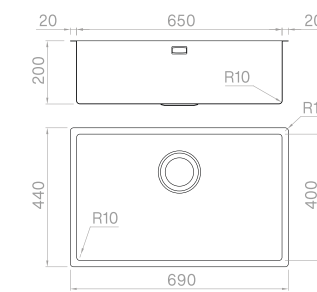

Accessori

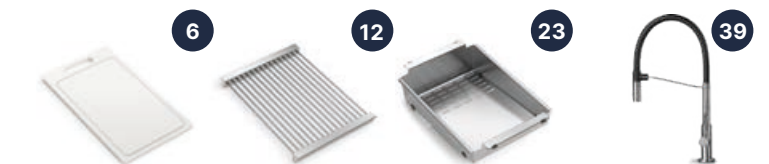

Vedi pag. 109 per tutti gli accessori dedicati.

RADIUS 50

READY



Tagliere in legno
 Vaschetta inclinata forata
 Miscelatore Hero

3
 23
 39



Cod. **SAB I 50 R1**
 Cod. **SABG 50 R1**
 Cod. **SABO 50 R1**

RADIUS 50

PRO



Vaschetta forata

16



Cod. **SBB I 50 R1**
 Cod. **SBBG 50 R1**
 Cod. **SBBO 50 R1**

RADIUS 50

SOLO



Materiale	AISI 304
Finitura	Spazzolato
Raggio interno	Saldato 10 mm
Misure esterne	540 × 440 mm
Misure vasca	500 × 400 mm
Profondità vasca	200 mm
Piletta standard	3 ½"
Base	600 mm

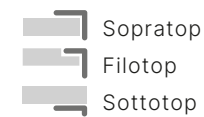

Cod. **BI 5040 R1**
 Cod. **BG 5040 R1**
 Cod. **BO 5040 R1**

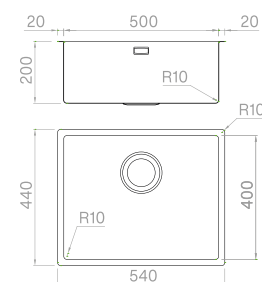

Accessori

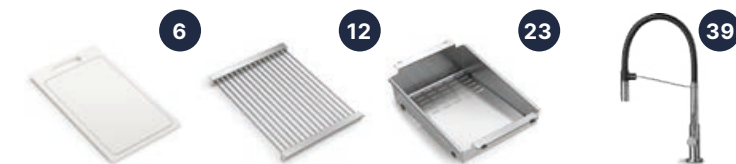

Vedi pag. 109 per tutti gli accessori dedicati.

RADIUS 45

READY

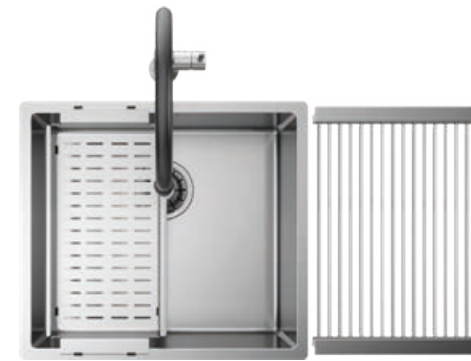

Griglia
 Vaschetta forata
 Miscelatore Hero

12
 16
 39



Cod. **SAB I 45 R1**
 Cod. **SABG 45 R1**
 Cod. **SABO 45 R1**

RADIUS 45

PRO



Vaschetta forata

16



Cod. **SBB I 45 R1**
 Cod. **SBBG 45 R1**
 Cod. **SBBO 45 R1**

RADIUS 45

SOLO



Materiale	AISI 304
Finitura	Spazzolato
Raggio interno	Saldato 10 mm
Misure esterne	490 × 440 mm
Misure vasca	450 × 400 mm
Profondità vasca	200 mm
Piletta standard	3 ½"
Base	600 mm



Cod. **BI 4540 R1**
 Cod. **BG 4540 R1**
 Cod. **BO 4540 R1**

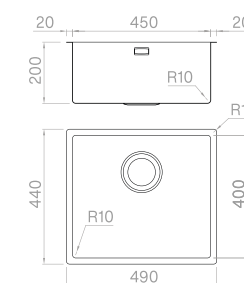

Accessori



Vedi pag. 109 per tutti gli accessori dedicati.

RADIUS 40 + 34

READY

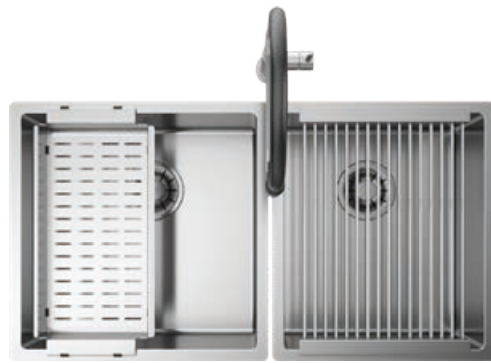

Griglia
Vaschetta forata
Miscelatore Hero

12
16
39



Cod. **SAB I 40 R1**
Cod. **SABG 40 R1**
Cod. **SABO 40 R1**

RADIUS 34+34

READY

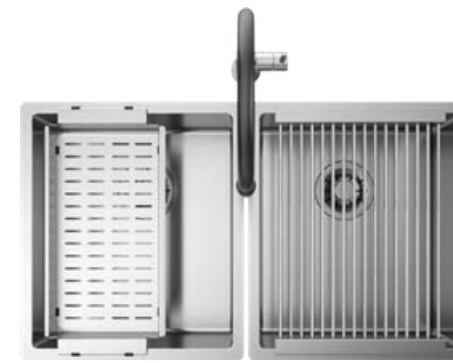

Griglia
Vaschetta forata
Miscelatore Hero

12
16
39



Cod. **SAB I 34 R1**
Cod. **SABG 34 R1**
Cod. **SABO 34 R1**

RADIUS 40

PRO



Vaschetta forata

16



Cod. **SBB I 40 R1**
Cod. **SBBG 40 R1**
Cod. **SBBO 40 R1**

RADIUS 34

PRO



Vaschetta forata

16



Cod. **SBB I 34 R1**
Cod. **SBBG 34 R1**
Cod. **SBBO 34 R1**

RADIUS 40

SOLO



Materiale	AISI 304
Finitura	Spazzolato
Raggio interno	Saldato 10 mm
Misure esterne	440 × 440 mm
Misure vasca	400 × 400 mm
Profondità vasca	200 mm
Piletta standard	3 ½"
Base	600 mm

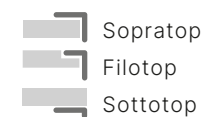

Cod. **BI 4040 R1**
Cod. **BG 4040 R1**
Cod. **BO 4040 R1**

RADIUS 34

SOLO



Materiale	AISI 304
Finitura	Spazzolato
Raggio interno	Saldato 10 mm
Misure esterne	380 × 440 mm
Misure vasca	340 × 400 mm
Profondità vasca	200 mm
Piletta standard	3 ½"
Base	600 mm

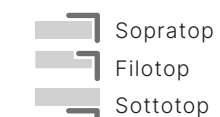

Cod. **BI 3440 R1**
Cod. **BG 3440 R1**
Cod. **BO 3440 R1**

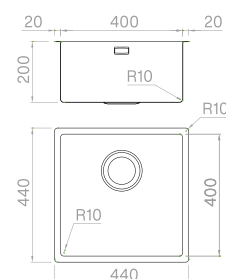

Accessori



Vedi pag. 109 per tutti gli accessori dedicati.

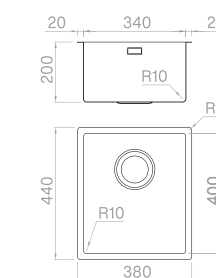

Accessori

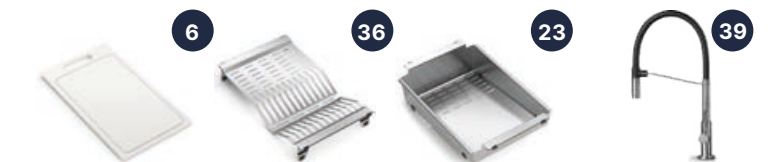

Vedi pag. 109 per tutti gli accessori dedicati.

**Tagliere in legno****3**

300×420×20 mm
Cod. **TRIB 3042**

**Tagliere in HDPE****6**

240×420×20 mm
Cod. **TRP 2442**

**Griglia****12**

250×420×25 mm
Cod. **GRS 2542**

**Vaschetta forata****16**

210×420×60 mm
Cod. **VQSF 2142**

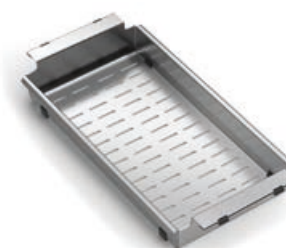
**Vaschetta inclinata forata****23**

280×420×110/60 mm
Cod. **VQSI 2842**

**Vaschetta****26**

280×420×160 mm
Cod. **VQSP 2842**

**Set gastronorm****30**

240×420×100 mm
Cod. **TI 2442 V**

**Set scolapasta****32**

240×420×100 mm
Cod. **TI 2442 1S**

**Set grattugie****34**

200×420×20 mm
Cod. **TI 2442 PG**

**Portapiatti****36**

250×420×55 mm
Cod. **PPPB V400**



GHOST

Ghost ha un ribassamento nella parete posteriore che consente l'alloggiamento del miscelatore all'interno dell'area operativa: una soluzione brillante in uno spazio contenuto e di qualità premium.



GHOST 60

READY



Cola pasta - set
Tagliere in HDPE
Miscelatore Circle

32
6
45

Sopratop
 Filotop
 Sottotop

Cod. **SAG I 60 RM**
 Cod. **SAGF 60 RM**
 Cod. **SAGO 60 RM**

GHOST 60

PRO



Tagliere in HDPE

6

Sopratop
 Filotop
 Sottotop

Cod. **SBG I 60 RM**
 Cod. **SBGF 60 RM**
 Cod. **SBGO 60 RM**

GHOST 60

SOLO



Materiale	AISI 304
Finitura	Spazzolato
Raggio interno	Saldato 10 mm
Misure esterne	440 × 520 mm
Misure vasca	400 × 400 + 80 mm
Profondità vasca	65/200 mm
Piletta Plus	3 ½"
Base	600 mm

Sopratop
 Filotop
 Sottotop

Cod. **SIG 60 RM**
 Cod. **SFG 60 RM**
 Cod. **SSG 60 RM**

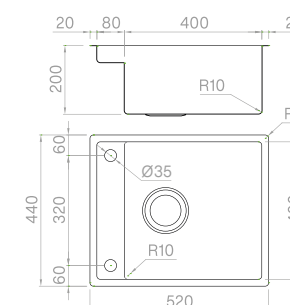

Accessori



Vedi pag. 113 per tutti gli accessori dedicati.

**Tagliere in legno**

300×420×20 mm
Cod. **TRIB 3042**

**3****Tagliere in HDPE**

240×420×20 mm
Cod. **TRP 2442**

**6****Griglia**

250×420×25 mm
Cod. **GRS 2542**

**12****Vaschetta forata**

210×420×60 mm
Cod. **VQSF 2142**

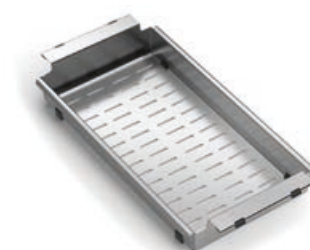
**16****Set gastronorm**

240×420×100 mm
Cod. **TI 2442 V**

**30****Set scolapasta**

240×420×100 mm
Cod. **TI 2442 1S**

**32****Set grattugie**

200×420×20 mm
Cod. **TI 2442 PG**

**34****Portapiatti**

250×420×55 mm
Cod. **PPPB V400**

**36**

MOSE

La collezione Mose è caratterizzata da lavelli a doppia vasca con ponte ribassato, che consente lo scorrimento degli accessori su tutta la lunghezza.

In alcuni modelli, l'alloggiamento del miscelatore è integrato nell'area operativa.



MOSE BR 81 **READY**

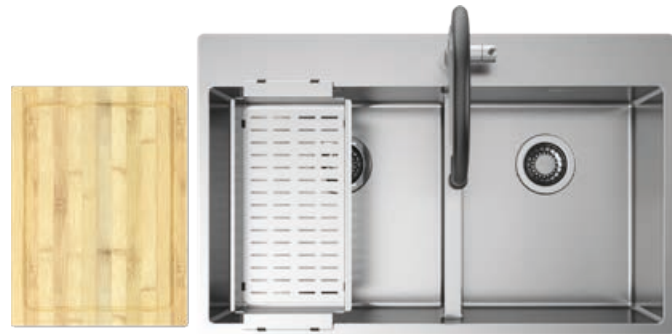

Tagliere in legno
Vaschetta forata
Miscelatore Hero

3
16
39



Cod. **SAM BR I 81**
Cod. **SAM BRG 81**

MOSE BR 81 **PRO**



Vaschetta forata

16



Cod. **SBM BR I 81**
Cod. **SBM BRG 81**

MOSE BR 81 **SOLO**



Materiale	AISI 304
Finitura	Spazzolato
Raggio interno	Saldato 10 mm
Misure esterne	810 × 510 mm
Misure vasca	400 × 400 mm / 340 × 400 mm
Profondità vasca	200 mm
Piletta standard	3 ½"
Base	900 mm



Cod. **ALM BR I 81**
Cod. **ALM BRG 81**

Foro miscelatore:
specificare fori extra
in fase di ordine.

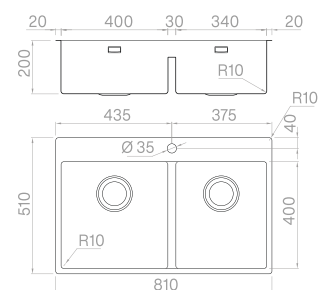

Accessori

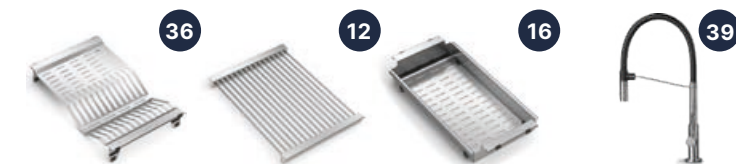

Vedi pag. 121 per tutti gli accessori dedicati.

MOSE BR 60 **READY**

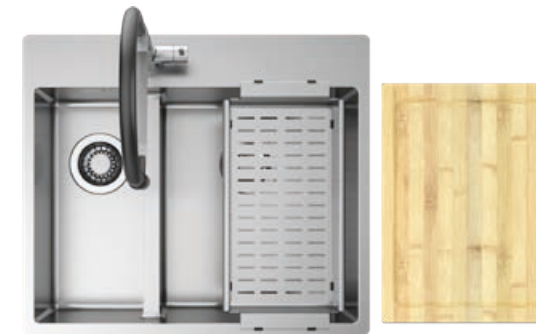

Tagliere in legno
Vaschetta forata
Miscelatore Hero

3
16
39



Cod. **SAM BR I 60**
Cod. **SAM BRG 60**

MOSE BR 60 **PRO**



Vaschetta forata

16



Cod. **SBM BR I 60**
Cod. **SBM BRG 60**

MOSE BR 60 **SOLO**



Materiale	AISI 304
Finitura	Spazzolato
Raggio interno	Saldato 10 mm
Misure esterne	590 × 510 mm
Misure vasca	180 × 400 mm / 340 × 400 mm
Profondità vasca	170 / 200 mm
Piletta standard	3 ½"
Base	600 mm



Cod. **ALM BR I 60**
Cod. **ALM BRG 60**

Foro miscelatore:
specificare fori extra
in fase di ordine.

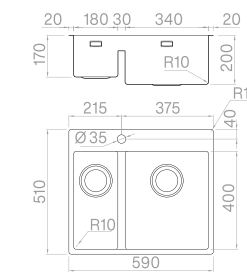

Accessori

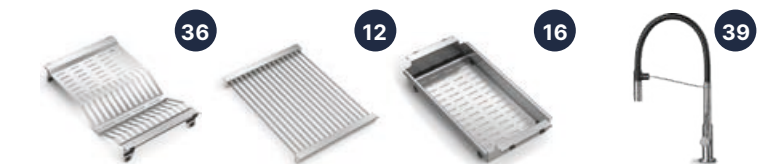

Vedi pag. 121 per tutti gli accessori dedicati.

MOSE SB 81

READY

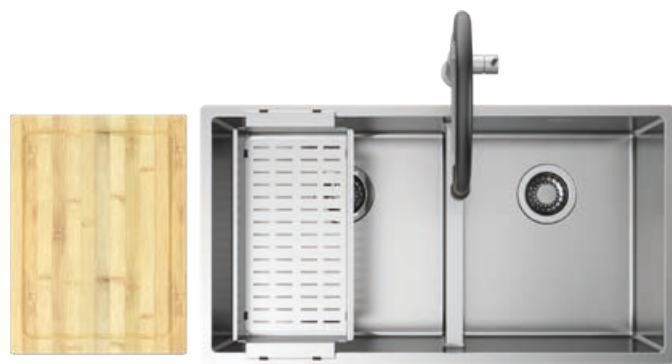

Tagliere in legno
Vaschetta forata
Miscelatore Hero

3
16
39



Cod. **SAM I 81 R1**
Cod. **SAMG 81 R1**
Cod. **SAMO 81 R1**

MOSE SB 81

PRO

Vaschetta forata

16



Cod. **SBM I 81 R1**
Cod. **SBMG 81 R1**
Cod. **SBMO 81 R1**

MOSE SB 81

SOLO



Materiale	AISI 304
Finitura	Spazzolato
Raggio interno	Saldato 10 mm
Misure esterne	810 × 440 mm
Misure vasca	400 × 400 mm / 340 × 400 mm
Profondità vasca	200 mm
Piletta standard	3 ½"
Base	900 mm



Cod. **MI 8140 R1**
Cod. **MG 8140 R1**
Cod. **MO 8140 R1**

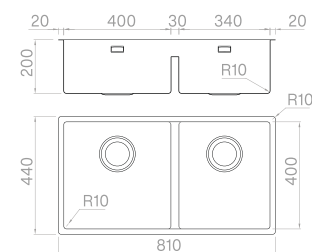

Accessori

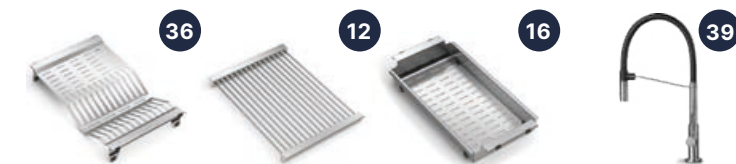

Vedi pag. 121 per tutti gli accessori dedicati.

MOSE SB 60

READY

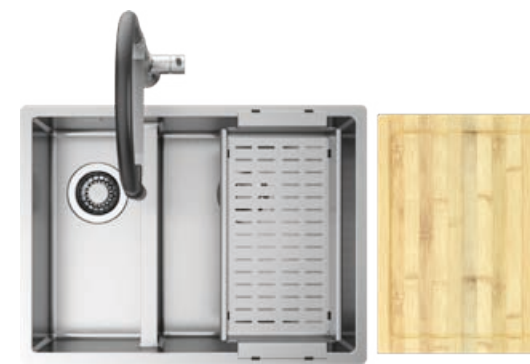

Tagliere in legno
Vaschetta forata
Miscelatore Hero

3
16
39



Cod. **SAM I 60 R1**
Cod. **SAMG 60 R1**
Cod. **SAMO 60 R1**

MOSE SB 60

PRO

Vaschetta forata

16



Cod. **SBM I 60 R1**
Cod. **SBMG 60 R1**
Cod. **SBMO 60 R1**

MOSE SB 60

SOLO



Materiale	AISI 304
Finitura	Spazzolato
Raggio interno	Saldato 10 mm
Misure esterne	590 × 440 mm
Misure vasca	180 × 400 mm / 340 × 400 mm
Profondità vasca	170 / 200 mm
Piletta standard	3 ½"
Base	600 mm



Cod. **MI 6040 R1**
Cod. **MG 6040 R1**
Cod. **MO 6040 R1**

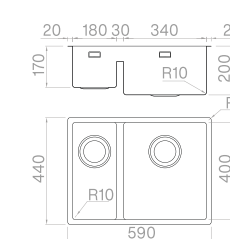

Accessori

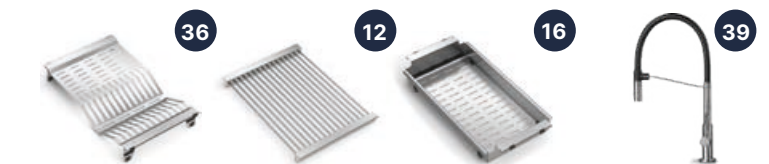

Vedi pag. 121 per tutti gli accessori dedicati.

Tagliere in legno

300×420×20 mm
Cod. **TRIB 3042**

**3****Tagliere in HDPE**

240×420×20 mm
Cod. **TRP 2442**

**6****Griglia**

250×420×25 mm
Cod. **GRS 2542**

**12****Vaschetta forata**

210×420×60 mm
Cod. **VQSF 2142**

**16****Portapiatti**

250×420×55 mm
Cod. **PPPB V400**

**36**

AQUA

Aqua è una collezione dalla grande capienza e dal design essenziale grazie agli angoli interni, sempre raggio di 10 mm. L'alloggiamento del miscelatore è integrato nell'area operativa.



AQUA 81

READY



Tagliere in legno
Vaschetta forata
Miscelatore Hero

3
16
39



Cod. **SAA I 81**
Cod. **SAAG 81**

AQUA 81

PRO



Vaschetta forata

16



Cod. **SBA I 81**
Cod. **SBAG 81**

AQUA 81

SOLO



Materiale	AISI 304
Finitura	Spazzolato
Raggio interno	Saldato 10 mm
Misure esterne	850 × 510 mm
Misure vasca	810 × 400 mm
Profondità vasca	200 mm
Piletta standard	3 ½"
Base	900 mm



Cod. **ALA I 81**
Cod. **ALAG 81**

Foro miscelatore:
specificare fori extra
in fase di ordine.

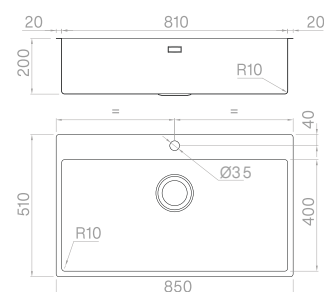

Accessori

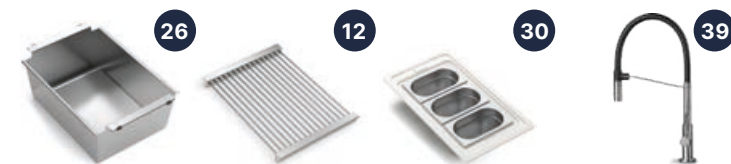

Vedi pag. 129 per tutti gli accessori dedicati.

AQUA 70

READY



Tagliere in legno
Vaschetta forata
Miscelatore Hero

3
16
39



Cod. **SAA I 70**
Cod. **SAAG 70**

AQUA 70

PRO



Vaschetta forata

16



Cod. **SBA I 70**
Cod. **SBAG 70**

AQUA 70

SOLO



Materiale	AISI 304
Finitura	Spazzolato
Raggio interno	Saldato 10 mm
Misure esterne	740 × 510 mm
Misure vasca	700 × 400 mm
Profondità vasca	200 mm
Piletta standard	3 ½"
Base	800 mm



Cod. **ALA I 70**
Cod. **ALAG 70**

Foro miscelatore:
specificare fori extra
in fase di ordine.

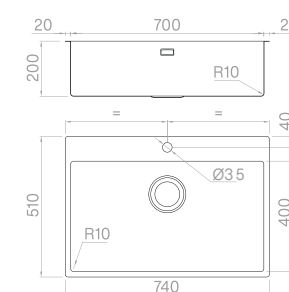

Accessori

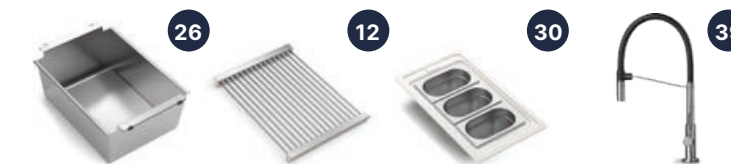

Vedi pag. 129 per tutti gli accessori dedicati.

AQUA 65

READY



Tagliere in legno
Vaschetta forata
Miscelatore Hero

3
16
39



Cod. **SAA I 65**
Cod. **SAAG 65**

AQUA 65

PRO



Vaschetta forata

16



Cod. **SBA I 65**
Cod. **SBAG 65**

AQUA 65

SOLO



Materiale	AISI 304
Finitura	Spazzolato
Raggio interno	Saldato 10 mm
Misure esterne	690 × 510 mm
Misure vasca	650 × 400 mm
Profondità vasca	200 mm
Piletta standard	3 ½"
Base	750 mm



Cod. **ALA I 65**
Cod. **ALAG 65**

Foro miscelatore:
specificare fori extra
in fase di ordine.

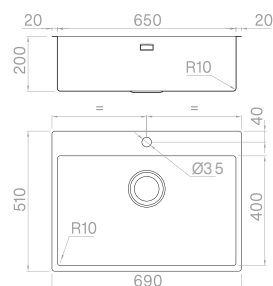

Accessori

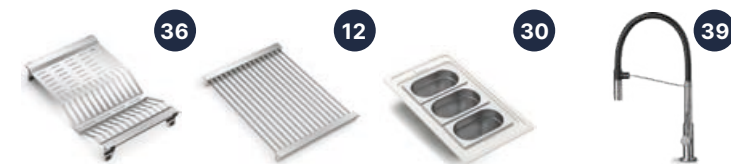

Vedi pag. 129 per tutti gli accessori dedicati.

AQUA 50

READY

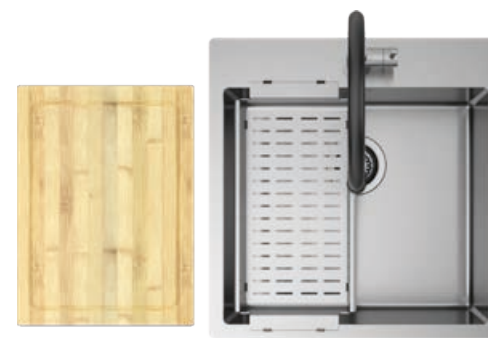

Tagliere in legno
Vaschetta forata
Miscelatore Hero

3
16
39



Cod. **SAA I 50**
Cod. **SAAG 50**

AQUA 50

PRO



Vaschetta forata

16



Cod. **SBA I 50**
Cod. **SBAG 50**

AQUA 50

SOLO



Materiale	AISI 304
Finitura	Spazzolato
Raggio interno	Saldato 10 mm
Misure esterne	540 × 510 mm
Misure vasca	500 × 400 mm
Profondità vasca	200 mm
Piletta standard	3 ½"
Base	600 mm



Cod. **ALA I 50**
Cod. **ALAG 50**

Foro miscelatore:
specificare fori extra
in fase di ordine.

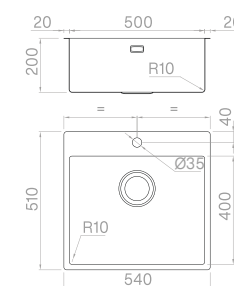

Accessori



Vedi pag. 129 per tutti gli accessori dedicati.

**Tagliere in legno****3**

300×420×20 mm
Cod. **TRIB 3042**

**Tagliere in HDPE****6**

240×420×20 mm
Cod. **TRP 2442**

**Griglia****12**

250×420×25 mm
Cod. **GRS 2542**

**Vaschetta forata****16**

210×420×60 mm
Cod. **VQSF 2142**

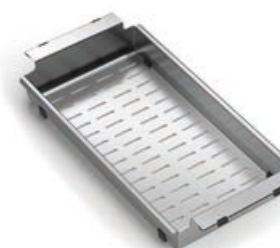
**Vaschetta inclinata forata****23**

280×420×110/60 mm
Cod. **VQSI 2842**

**Vaschetta****26**

280×420×160 mm
Cod. **VQSP 2842**

**Set gastronorm****30**

240×420×100 mm
Cod. **TI 2442 V**

**Set scolapasta****32**

240×420×100 mm
Cod. **TI 2442 1S**

**Set grattugie****34**

200×420×20 mm
Cod. **TI 2442 PG**

**Portapiatti****36**

250×420×55 mm
Cod. **PPPB V400**





PRISMA

Un connubio perfetto tra precisione e geometria: in Prisma gli angoli delle pareti a raggio zero si uniscono al fondo grazie a un esclusivo perimetro inclinato a 45°.



PRISMA 81

READY



- Tagliere in legno
- Vaschetta inclinata forata
- Vaschetta
- Miscelatore Element

- 3
- 23
- 26
- 40

- Sopratop
- Filotop
- Sottotop

- Cod. **SAPR I 81**
- Cod. **SAPRG 81**
- Cod. **SAPRO 81**

PRISMA 81

PRO



- Vaschetta forata

- 16

- Sopratop
- Filotop
- Sottotop

- Cod. **SBPR I 81**
- Cod. **SBPRG 81**
- Cod. **SBPRO 81**

PRISMA 81

SOLO



- Materiale AISI 304
- Finitura Spazzolato
- Raggio interno Saldato 0 mm
- Misure esterne 850 × 440 mm
- Misure vasca 810 × 400 mm
- Profondità vasca 200 mm
- Piletta standard 3 1/2"
- Base 900 mm

- Sopratop
- Filotop
- Sottotop

- Cod. **PR I 81**
- Cod. **PR G 81**
- Cod. **PR O 81**

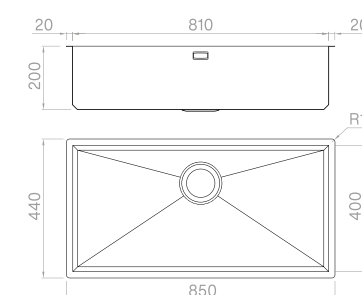

Accessori

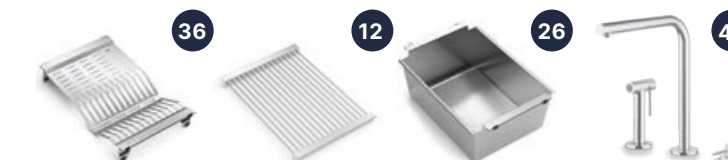

Vedi pag. 141 per tutti gli accessori dedicati.

PRISMA 70

READY



- Tagliere in legno
- Vaschetta inclinata forata
- Vaschetta
- Miscelatore Element

- 3
- 23
- 26
- 40

- Sopratop
- Filotop
- Sottotop

- Cod. **SAPR I 70**
- Cod. **SAPRG 70**
- Cod. **SAPRO 70**

PRISMA 65

READY



- Tagliere in legno
- Vaschetta inclinata forata
- Miscelatore Vertigo

- 3
- 23
- 47

- Sopratop
- Filotop
- Sottotop

- Cod. **SAPR I 65**
- Cod. **SAPRG 65**
- Cod. **SAPRO 65**

PRISMA 70

PRO



- Vaschetta forata

- 16

- Sopratop
- Filotop
- Sottotop

- Cod. **SBPR I 70**
- Cod. **SBPRG 70**
- Cod. **SBPRO 70**

PRISMA 65

PRO



- Vaschetta forata

- 16

- Sopratop
- Filotop
- Sottotop

- Cod. **SBPR I 65**
- Cod. **SBPRG 65**
- Cod. **SBPRO 65**

PRISMA 70

SOLO



- | | |
|------------------|--------------|
| Materiale | AISI 304 |
| Finitura | Spazzolato |
| Raggio interno | Saldato 0 mm |
| Misure esterne | 740 × 440 mm |
| Misure vasca | 700 × 400 mm |
| Profondità vasca | 200 mm |
| Piletta standard | 3 ½" |
| Base | 800 mm |

- Sopratop
- Filotop
- Sottotop

- Cod. **PR I 70**
- Cod. **PR G 70**
- Cod. **PR O 70**

PRISMA 65

SOLO



- | | |
|------------------|--------------|
| Materiale | AISI 304 |
| Finitura | Spazzolato |
| Raggio interno | Saldato 0 mm |
| Misure esterne | 690 × 440 mm |
| Misure vasca | 650 × 400 mm |
| Profondità vasca | 200 mm |
| Piletta standard | 3 ½" |
| Base | 750 mm |

- Sopratop
- Filotop
- Sottotop

- Cod. **PR I 65**
- Cod. **PR G 65**
- Cod. **PR O 65**

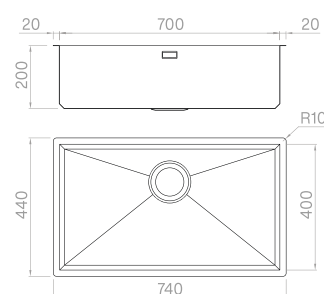

Accessori

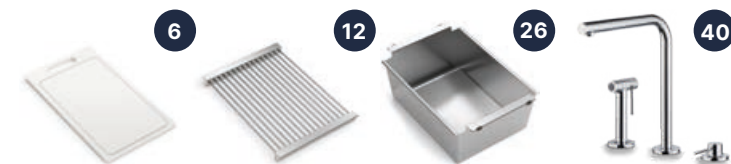

Vedi pag. 141 per tutti gli accessori dedicati.

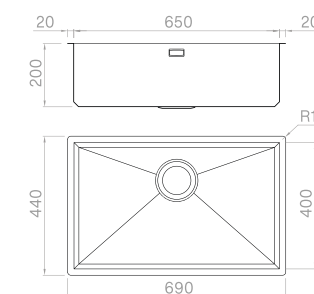

Accessori

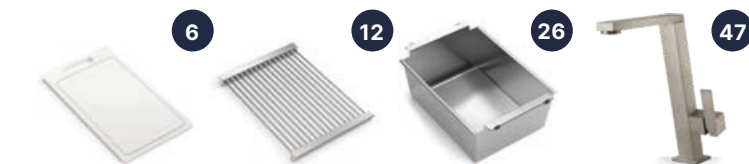

Vedi pag. 141 per tutti gli accessori dedicati.

PRISMA 50

READY



Tagliere in legno
 Vaschetta inclinata forata
 Miscelatore Vertigo

3
 23
 47

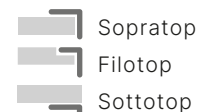

Cod. **SAPR I 50**
 Cod. **SAPRG 50**
 Cod. **SAPRO 50**

PRISMA 50

PRO



Vaschetta forata

16



Cod. **SBPR I 50**
 Cod. **SBPRG 50**
 Cod. **SBPRO 50**

PRISMA 50

SOLO



Materiale	AISI 304
Finitura	Spazzolato
Raggio interno	Saldato 0 mm
Misure esterne	540 × 440 mm
Misure vasca	500 × 400 mm
Profondità vasca	200 mm
Piletta standard	3 ½"
Base	600 mm

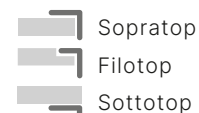

Cod. **PR I 50**
 Cod. **PR G 50**
 Cod. **PR O 50**

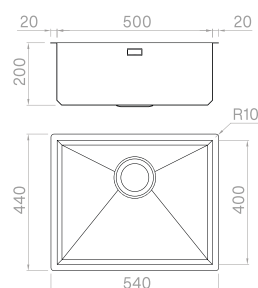

Accessori

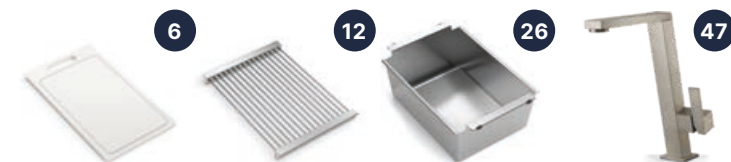

Vedi pag. 141 per tutti gli accessori dedicati.

PRISMA 45

READY

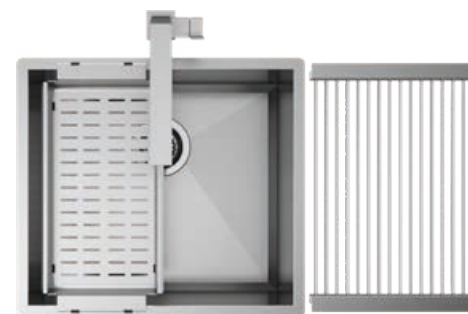

Griglia
 Vaschetta forata
 Miscelatore Vertigo

12
 16
 47



Cod. **SAPR I 45**
 Cod. **SAPRG 45**
 Cod. **SAPRO 45**

PRISMA 45

PRO



Vaschetta forata

16



Cod. **SBPR I 45**
 Cod. **SBPRG 45**
 Cod. **SBPRO 45**

PRISMA 45

SOLO



Materiale	AISI 304
Finitura	Spazzolato
Raggio interno	Saldato 0 mm
Misure esterne	490 × 440 mm
Misure vasca	450 × 400 mm
Profondità vasca	200 mm
Piletta standard	3 ½"
Base	600 mm

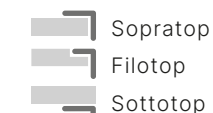

Cod. **PR I 45**
 Cod. **PR G 45**
 Cod. **PR O 45**

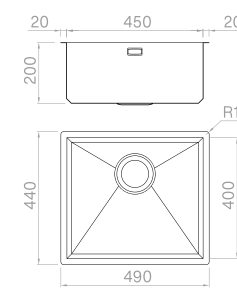

Accessori



Vedi pag. 141 per tutti gli accessori dedicati.

PRISMA 40 + 34

READY

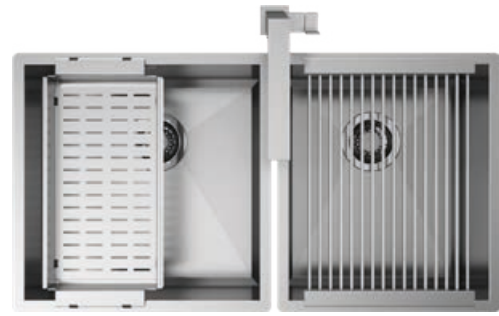

Griglia
Vaschetta forata
Miscelatore Vertigo

12
16
47



Cod. **SAPR I 40**
Cod. **SAPRG 40**
Cod. **SAPRO 40**

PRISMA 34 + 34

READY

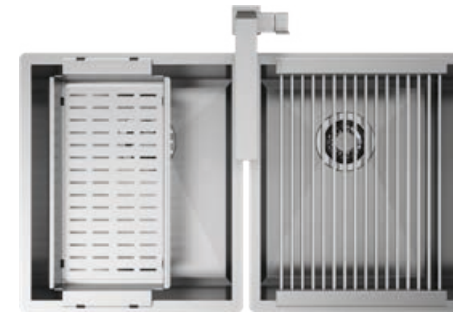

Griglia
Vaschetta forata
Miscelatore Vertigo

12
16
47



Cod. **SAPR I 34**
Cod. **SAPRG 34**
Cod. **SAPRO 34**

PRISMA 40

PRO

Vaschetta forata

16



Cod. **SBPR I 40**
Cod. **SBPRG 40**
Cod. **SBPRO 40**

PRISMA 34

PRO

Vaschetta forata

16



Cod. **SBPR I 34**
Cod. **SBPRG 34**
Cod. **SBPRO 34**

PRISMA 40

SOLO

Materiale	AISI 304
Finitura	Spazzolato
Raggio interno	Saldato 0 mm
Misure esterne	440 × 440 mm
Misure vasca	400 × 400 mm
Profondità vasca	200 mm
Piletta standard	3 ½"
Base	600 mm

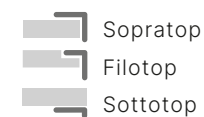

Cod. **PR I 40**
Cod. **PR G 40**
Cod. **PR O 40**

PRISMA 34

SOLO

Materiale	AISI 304
Finitura	Spazzolato
Raggio interno	Saldato 0 mm
Misure esterne	380 × 440 mm
Misure vasca	340 × 400 mm
Profondità vasca	200 mm
Piletta standard	3 ½"
Base	600 mm

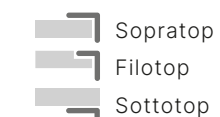

Cod. **PR I 34**
Cod. **PR G 34**
Cod. **PR O 34**

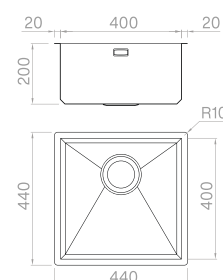

Accessori

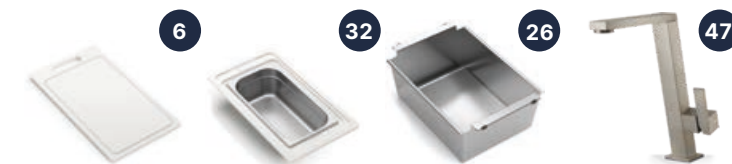

Vedi pag. 141 per tutti gli accessori dedicati.

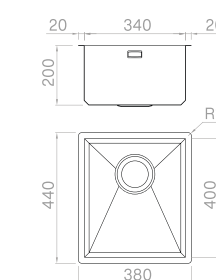

Accessori

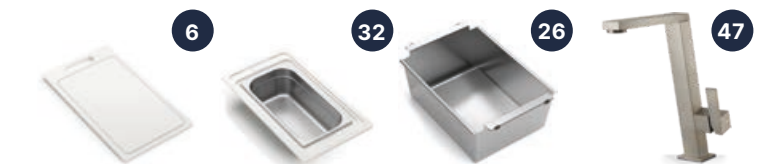

Vedi pag. 141 per tutti gli accessori dedicati.

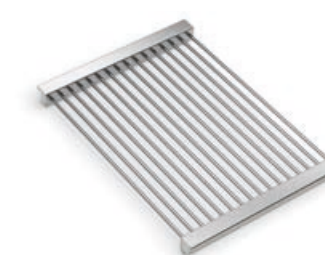
Tagliere in legno**3**300×420×20 mm
Cod. **TRIB 3042****Tagliere in HDPE****6**240×420×20 mm
Cod. **TRP 2442****Griglia****12**250×420×25 mm
Cod. **GRS 2542****Vaschetta forata****16**210×420×60 mm
Cod. **VQSF 2142****Vaschetta inclinata forata****23**280×420×110/60 mm
Cod. **VQSI 2842****Vaschetta****26**280×420×160 mm
Cod. **VQSP 2842****Set gastronorm****30**240×420×100 mm
Cod. **TI 2442 V****Set scolapasta****32**240×420×100 mm
Cod. **TI 2442 1S****Set grattugie****34**200×420×20 mm
Cod. **TI 2442 PG****Portapiatti****36**250×420×55 mm
Cod. **PPPB V400**

LINEA

La caratteristica di Linea è l'esclusiva installazione Edgeless, dove bordo e giunzioni tra vasca e piano spariscono, massimizzando estetica e pulizia.



LINEA 70

READY

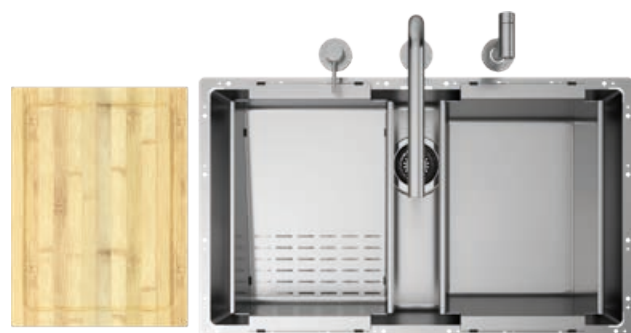

- Tagliere in legno
- Vaschetta inclinata forata
- Vaschetta
- Miscelatore Element

- 3
- 23
- 26
- 40



Cod. **SAL 70**

LINEA 70

PRO



- Vaschetta forata

- 16



Cod. **SBL 70**

LINEA 70

SOLO



- | | |
|------------------|---------------|
| Materiale | AISI 304 |
| Finitura | Spazzolato |
| Raggio interno | Saldato 10 mm |
| Misure esterne | - |
| Misure vasca | 700 × 400 mm |
| Profondità vasca | 200 mm |
| Piletta standard | 3 ½" |
| Base | 800 mm |



Cod. **L 70**

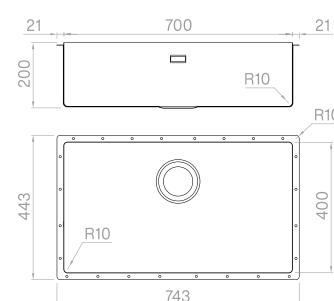

Accessori

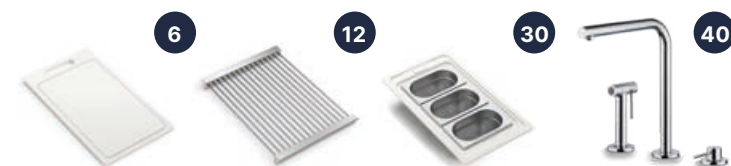

Vedi pag. 151 per tutti gli accessori dedicati.

LINEA 65

READY



- Tagliere in legno
- Vaschetta inclinata forata
- Miscelatore Uber

- 3
- 23
- 46



Cod. **SAL 65**

LINEA 65

PRO



- Vaschetta forata

- 16



Cod. **SBL 65**

LINEA 65

SOLO



- | | |
|------------------|---------------|
| Materiale | AISI 304 |
| Finitura | Spazzolato |
| Raggio interno | Saldato 10 mm |
| Misure esterne | - |
| Misure vasca | 650 × 400 mm |
| Profondità vasca | 200 mm |
| Piletta standard | 3 ½" |
| Base | 750 mm |



Cod. **L 65**

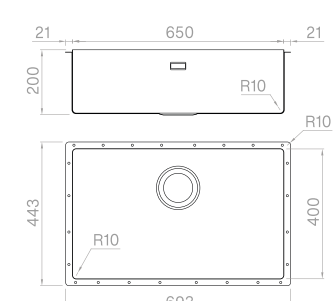

Accessori

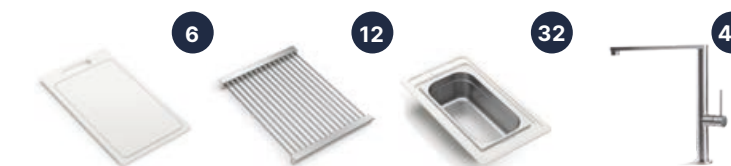

Vedi pag. 151 per tutti gli accessori dedicati.

LINEA 50

READY



- Tagliere in legno
- Vaschetta inclinata forata
- Miscelatore Uber

3
23
46



Cod. **SAL 50**

LINEA 50

PRO



- Vaschetta forata

16



Cod. **SBL 50**

LINEA 50

SOLO



- | | |
|------------------|---------------|
| Materiale | AISI 304 |
| Finitura | Spazzolato |
| Raggio interno | Saldato 10 mm |
| Misure esterne | - |
| Misure vasca | 500 × 400 mm |
| Profondità vasca | 200 mm |
| Piletta standard | 3 ½" |
| Base | 600 mm |



Cod. **L 50**

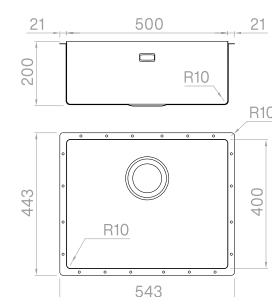

Accessori

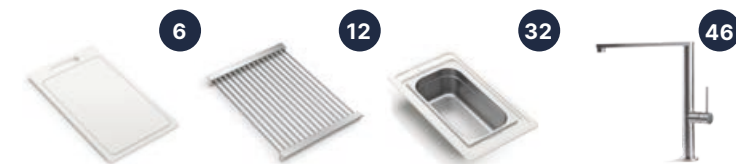

Vedi pag. 151 per tutti gli accessori dedicati.

LINEA 45

READY

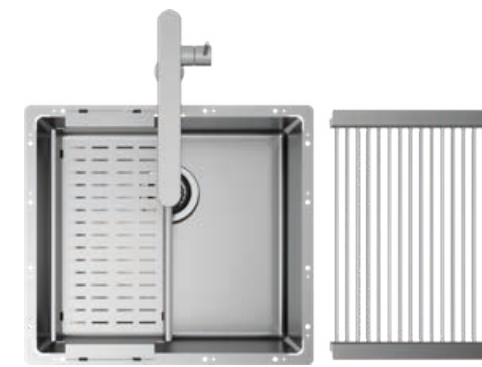

- Griglia
- Vaschetta forata
- Miscelatore Uber

12
16
46



Cod. **SAL 45**

LINEA 45

PRO



- Vaschetta forata

16



Cod. **SBL 45**

LINEA 45

SOLO



- | | |
|------------------|---------------|
| Materiale | AISI 304 |
| Finitura | Spazzolato |
| Raggio interno | Saldato 10 mm |
| Misure esterne | - |
| Misure vasca | 450 × 400 mm |
| Profondità vasca | 200 mm |
| Piletta standard | 3 ½" |
| Base | 600 mm |



Cod. **L 45**

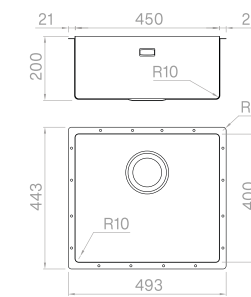

Accessori



Vedi pag. 151 per tutti gli accessori dedicati.

LINEA 40

READY

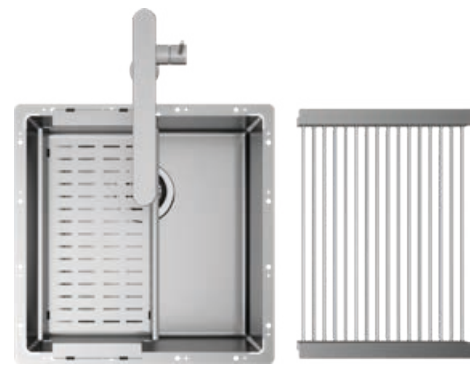

Griglia
Vaschetta forata
Miscelatore Uber

12
16
46



Cod. **SAL 40**

LINEA 40

PRO



Vaschetta forata

16



Cod. **SBL 40**

LINEA 40

SOLO



Materiale	AISI 304
Finitura	Spazzolato
Raggio interno	Saldato 10 mm
Misure esterne	-
Misure vasca	400 × 400 mm
Profondità vasca	200 mm
Piletta standard	3 ½"
Base	600 mm



Cod. **L 40**

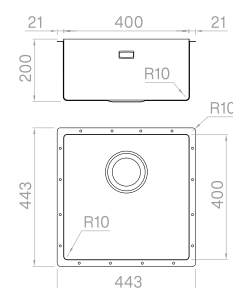

Accessori



Vedi pag. 151 per tutti gli accessori dedicati.

LINEA 34

READY

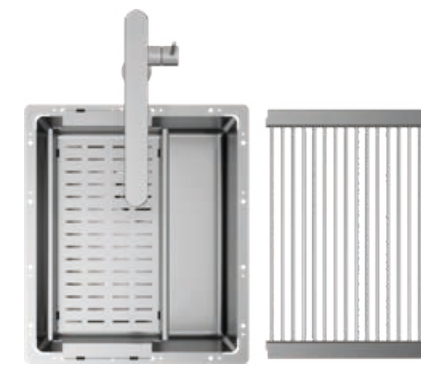

Griglia
Vaschetta forata
Miscelatore Uber

12
16
46



Cod. **SAL 34**

LINEA 34

PRO



Vaschetta forata

16



Cod. **SBL 34**

LINEA 34

SOLO



Materiale	AISI 304
Finitura	Spazzolato
Raggio interno	Saldato 10 mm
Misure esterne	-
Misure vasca	340 × 400 mm
Profondità vasca	200 mm
Piletta standard	3 ½"
Base	600 mm



Cod. **L 34**

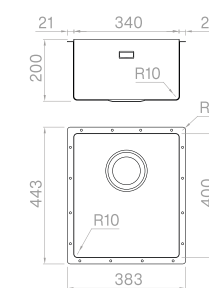

Accessori



Vedi pag. 151 per tutti gli accessori dedicati.

**Tagliere in legno****3**

300×420×20 mm
Cod. **TRIB 3042**

**Tagliere in HDPE****6**

240×420×20 mm
Cod. **TRP 2442**

**Griglia****12**

250×420×25 mm
Cod. **GRS 2542**

**Vaschetta forata****16**

210×420×60 mm
Cod. **VQSF 2142**

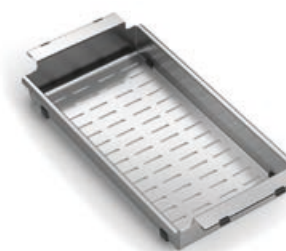
**Vaschetta inclinata forata****23**

280×420×110/60 mm
Cod. **VQSI 2842**

**Vaschetta****26**

280×420×160 mm
Cod. **VQSP 2842**

**Set gastronorm****30**

240×420×100 mm
Cod. **TI 2442 V**

**Set scolapasta****32**

240×420×20 mm
Cod. **TI 2442 1S**

**Set grattugie****34**

200×420×20 mm
Cod. **TI 2442 PG**

**Portapiatti****36**

250×420×55 mm
Cod. **PPPB V400**



SHORE

Shore presenta l'innovativa installazione con pareti in continuità al piano di lavoro e il fondo in acciaio inox a vista dall'esclusivo perimetro inclinato a 45°.



SHORE 70

READY



- Tagliere in legno
- Vaschetta inclinata forata
- Miscelatore Element

3
23
40

Integrato

Cod. **SASH 70**

SHORE 70

PRO



Vaschetta forata

16

Integrato

Cod. **SBSH 70**

SHORE 70

SOLO



- | | |
|------------------|--------------|
| Materiale | AISI 304 |
| Finitura | Spazzolato |
| Raggio interno | Saldato 0 mm |
| Misure esterne | 766 × 466 mm |
| Misure vasca | 700 × 400 mm |
| Profondità vasca | 175 mm |
| Piletta standard | 3 ½" |
| Base | 800 mm |

Integrato

Cod. **SH 70**

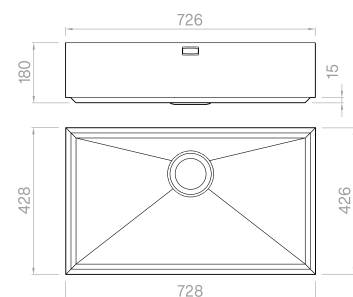

Accessori

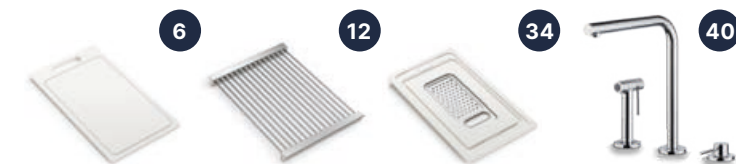

Vedi pag. 161 per tutti gli accessori dedicati.

SHORE 65

READY



- Tagliere in legno
- Vaschetta inclinata forata
- Miscelatore Element

3
23
40

Integrato

Cod. **SASH 65**

SHORE 65

PRO



Vaschetta forata

16

Integrato

Cod. **SBSH 65**

SHORE 65

SOLO



- | | |
|------------------|--------------|
| Materiale | AISI 304 |
| Finitura | Spazzolato |
| Raggio interno | Saldato 0 mm |
| Misure esterne | 716 × 466 mm |
| Misure vasca | 650 × 400 mm |
| Profondità vasca | 175 mm |
| Piletta standard | 3 ½" |
| Base | 750 mm |

Integrato

Cod. **SH 65**

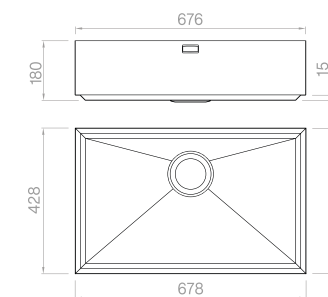

Accessori

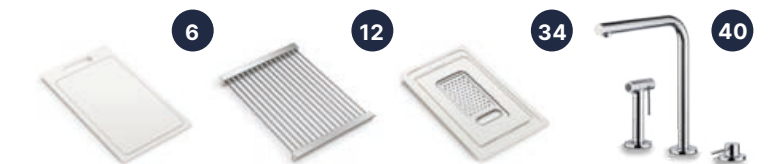

Vedi pag. 161 per tutti gli accessori dedicati.

SHORE 50

READY



- Tagliere in legno
- Vaschetta inclinata forata
- Miscelatore Element

3
23
40

Integrato

Cod. **SASH 50**

SHORE 50

PRO



- Vaschetta forata

16

Integrato

Cod. **SBSH 50**

SHORE 50

SOLO



- | | |
|------------------|--------------|
| Materiale | AISI 304 |
| Finitura | Spazzolato |
| Raggio interno | Saldato 0 mm |
| Misure esterne | 566 × 466 mm |
| Misure vasca | 500 × 400 mm |
| Profondità vasca | 175 mm |
| Piletta standard | 3 ½" |
| Base | 600 mm |

Integrato

Cod. **SH 50**

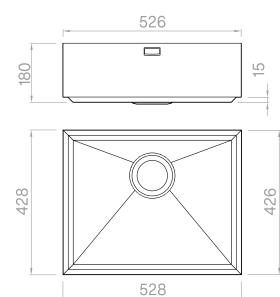

Accessori

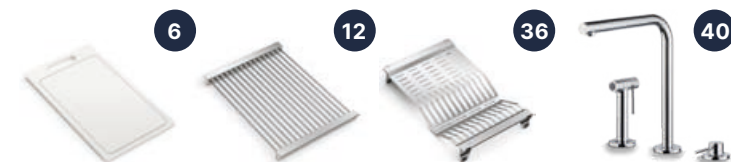

Vedi pag. 161 per tutti gli accessori dedicati.

SHORE 45

READY



- Griglia
- Vaschetta forata
- Miscelatore Uber

12
16
46

Integrato

Cod. **SASH 45**

SHORE 45

PRO



- Vaschetta forata

16

Integrato

Cod. **SBSH 45**

SHORE 45

SOLO



- | | |
|------------------|--------------|
| Materiale | AISI 304 |
| Finitura | Spazzolato |
| Raggio interno | Saldato 0 mm |
| Misure esterne | 516 × 466 mm |
| Misure vasca | 450 × 400 mm |
| Profondità vasca | 175 mm |
| Piletta standard | 3 ½" |
| Base | 600 mm |

Integrato

Cod. **SH 45**

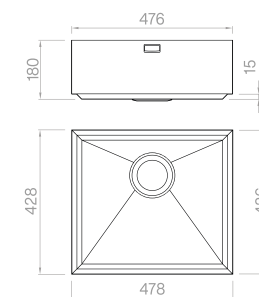

Accessori



Vedi pag. 161 per tutti gli accessori dedicati.

SHORE 40 + 34

READY

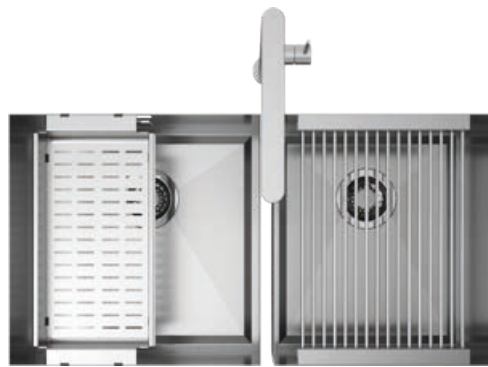

Griglia
Vaschetta forata
Miscelatore Uber

12
16
46

Integrato

Cod. **SASH 40**

SHORE 34 + 34

READY

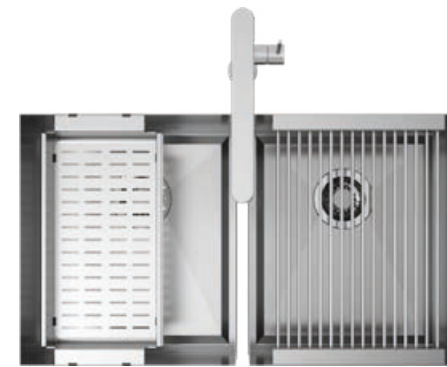

Griglia
Vaschetta forata
Miscelatore Uber

12
16
46

Integrato

Cod. **SASH 34**

SHORE 40

PRO

Vaschetta forata

16



Integrato

Cod. **SBSH 40**

SHORE 34

PRO

Vaschetta forata

16



Integrato

Cod. **SBSH 34**

SHORE 40

SOLO



Materiale	AISI 304
Finitura	Spazzolato
Raggio interno	Saldato 0 mm
Misure esterne	466 × 466 mm
Misure vasca	400 × 400 mm
Profondità vasca	175 mm
Piletta standard	3 ½"
Base	600 mm

Integrato

Cod. **SH 40**

SHORE 34

SOLO



Materiale	AISI 304
Finitura	Spazzolato
Raggio interno	Saldato 0 mm
Misure esterne	406 × 466 mm
Misure vasca	340 × 400 mm
Profondità vasca	175 mm
Piletta standard	3 ½"
Base	600 mm

Integrato

Cod. **SH 34**

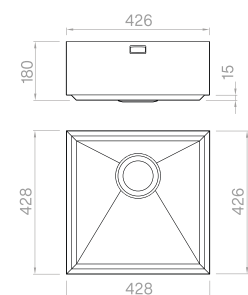

Accessori

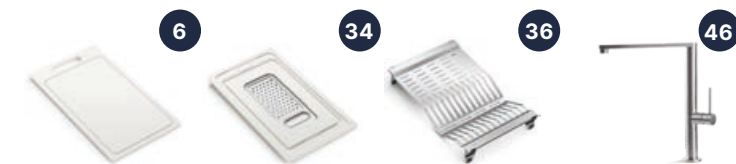

Vedi pag. 161 per tutti gli accessori dedicati.

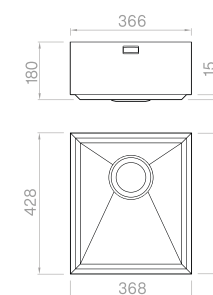

Accessori

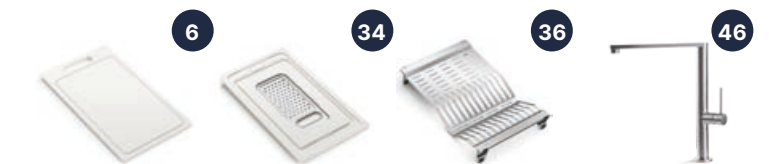

Vedi pag. 161 per tutti gli accessori dedicati.

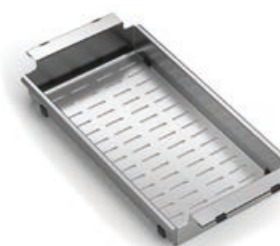
Tagliere in legno**3**300×420×20 mm
Cod. **TRIB 3042****Tagliere in HDPE****6**240×420×20 mm
Cod. **TRP 2442****Griglia****12**250×420×25 mm
Cod. **GRS 2542****Vaschetta forata****16**210×420×60 mm
Cod. **VQSF 2142****Vaschetta inclinata forata****23**280×420×110/60 mm
Cod. **VQSI 2842****Vaschetta****26**280×420×160 mm
Cod. **VQSP 2842****Set gastronorm****30**240×420×100 mm
Cod. **TI 2442 V****Set scolapasta****32**240×420×100 mm
Cod. **TI 2442 1S****Set grattugie****34**200×420×20 mm
Cod. **TI 2442 PG****Portapiatti****36**250×420×55 mm
Cod. **PPPB V400**